



Easy Fabric Display System & Graphics

+86-(0)21-5953-2516
sales@tlfAdvertising.com
www.tlfAdvertising.com
info@tlfAdvertising.com

ADD:17th Fengbang Industrial Park No.3652 Cao'an Road,Shanghai China

3 **CANOPY TENT**
Tent Frame And Fabric
Standard Sizes
Tent Accessories

11 **FLAG**
Flag Pole
Flag
Flag Bases

19 **INFLATABLE SERIES**
Inflatable Tent
Inflatable Arch
Inflatable Furniture

23 **BARRIER STAND**
Barrier Stand

24
25 **POP OUT BANNER**
Pop Out Banner

26

OUTDOOR
TABLE OF
CONTENTS / **1**

INDOOR
TABLE OF
CONTENTS / **27**

29 **BACKDROP STAND**
Tension Fabric EZ Tube Wall
44 **POP UP DISPLAY**
Adjustable Banner Stand

45 **DISPLAY STAND & SIGN**
Counter Series
Display Rack Series
58 **SEG MODULAR LIGHTBOX**
Tube Banner Stand

63 **TABLE COVERS**
Table Throw
64 **STRETCH TABLE COVER**
Fitted Table Cover

59 **DISPLAY STAND & SIGN**
Hanging Ceiling Sign
62 **CHANGING ROOM**
Arch Series

65 **BOOTH**
Booth Solution
Booth Accessories Series
74 **FABRIC**

OUTDOOR

SHANGHAI TLF ADVERTISING CO.,LTD

TLF
ADVERTISING



Outdoor display signage is typically bright and rugged to withstand the elements. From folding tent signs to full motion graphics, outdoor printed displays can make a big impact to an audience on foot, in cars or sitting still.

FOLDING TENT FRAME

Folding custom tent is a good option for event shade and promotion sign. TLF manufacture hex40mm popular type frame and hex50mm premium quality frame to meet different demands.

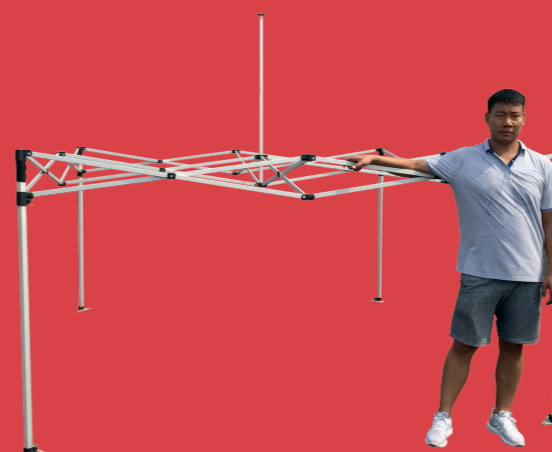

Folding Tent Hex40mm Series

Outer Tube : 40x40x40x1.2mm
Inner Tube : 35x35x35x1.2mm
Truss Tube : 32*16*1.2mm
Connectors : ABS plastic

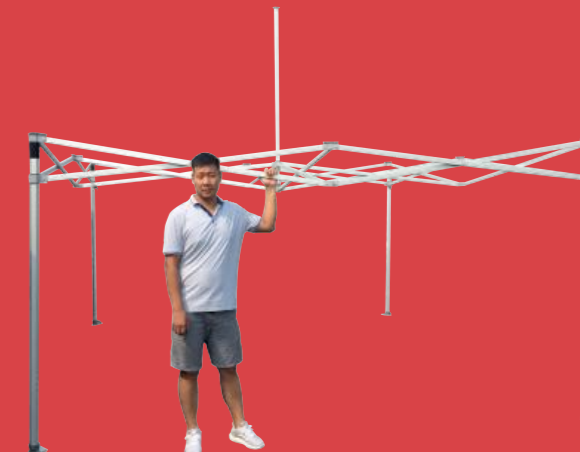

Folding Tent Hex50mm Series

Outer Tube : 50*50*50*1.8mm
Inner Tube : 45*45*45*1.8mm
Truss Tube : 32*16*1.8mm
Connectors : aluminum



CUSTOM CANOPY TENT

Folding custom tent is a good option for event shade and promotion sign. It will be the first choice for outdoor trade show booth.

Folding Tent Hex40mm Series

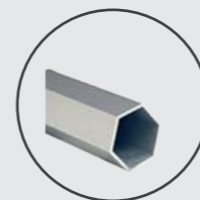

Hex 40mm Tube
Thickness 1.2mm



Plastic Connectors



Plastic Adjustor
Spring Inside

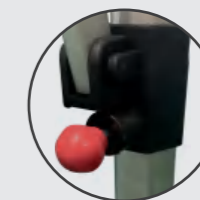

Up-Down Bukles
Downward Stretch

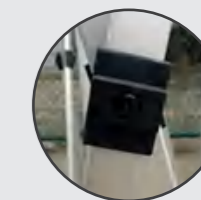

Steel Screw

Folding Tent Hex50mm Series

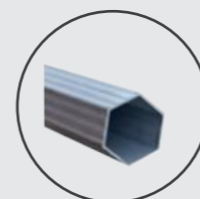

Hex 50mm Tube
Thickness 1.8mm



Aluminum Alloy
Connectors



Aluminium Alloy Adjustor
Spring Outside



Up-Down Bukles
Stretch Forward

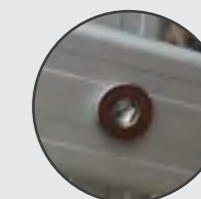

Stainless Steel
Screws

ROOF AND WALL

There are various processes for the tent roof and walls, TLF accept customized roof and wall according to your requirements. We do the most popular and practical finishes as below:

Buckles on valances



Velcro--roof to frame



Velcro hook on sides of wall



Zipper for wall connect



Clamps for half wall

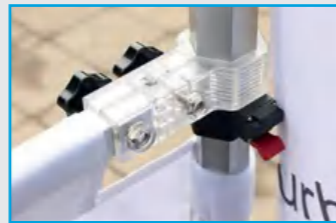

Awning

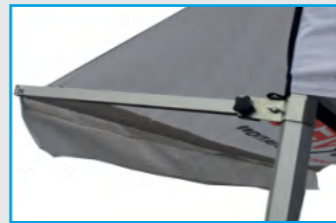

Tent Wall Match



Custom Canopy Package A



Custom Canopy w/wall Package B



Custom Canopy w/walls Package C

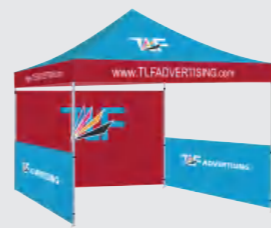

Custom Canopy w/2railskirts Package D

Custom Canopy w/3railskirts Package E



Custom Canopy w/3walls Package F

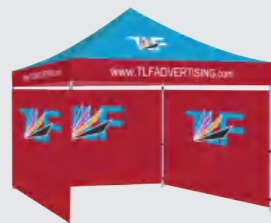

Custom Canopy 3Walls/railskirts Package G



Custom Canopy w/4walls Package H



POPULAR SIZES

Most popular sizes: 3x3m, 3x4.5m, 3x6m(10x10ft,10x15ft,10x20ft)



Hex 40mm Hex 50mm

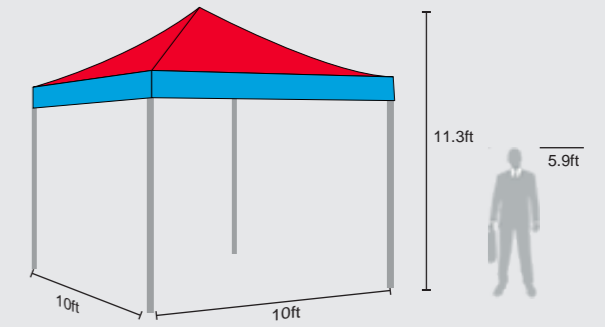

3x3m/10x10ft Tent Frame

Item	Hex40mm	Hex50mm
Gross Weight	18.5kg/40.7lbs	31kg/68lbs
Net Weight	17.2kg/37.9lbs	29.7kg/65.4lbs
Package Size	160x26x26cm 63x10x10inch	160x33x33cm 63x12.9x12.9inch



Hex 40mm Hex 50mm

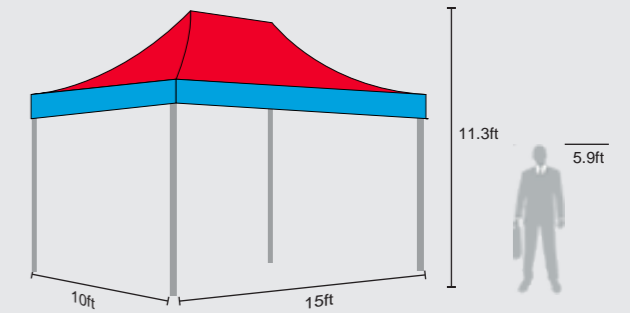

3x4.5m/10x15ft Tent Frame

Item	Hex40mm	Hex50mm
Gross Weight	23kg/51lbs	39kg/86lbs
Net Weight	21.5kg/47.4lbs	38.5kg/85kg
Package Size	160x35x26cm 63x13.7x10inch	160x35x46cm 63x13.7x18.1inch



Hex 40mm Hex 50mm

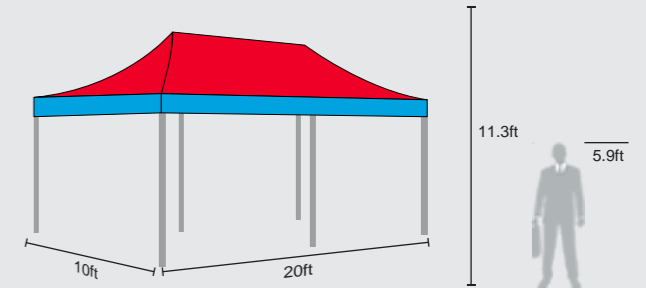

3x6m/10x20ft Tent Frame

Item	Hex40mm	Hex50mm
Gross Weight	31kg/68lbs	53kg/117lbs
Net Weight	29.5kg/65lbs	51.5kg/113.5lbs
Package Size	160x45x26cm 63x17.7x10inch	160x35x60cm 63x13.7x23.6inch

STANDARD SIZES

Other common sizes: 1.5x1.5m, 2.5x2.5m, 4x4m, 4x6m, 4x8m, 6x6m, Hex-Shape Dia 3m (5x5ft, 8x8ft, 13x13ft, 13x20ft, 13x26ft, 20x20ft, Hex-Shape Dia 10ft)

WWW.TLFADVERTISING.COM

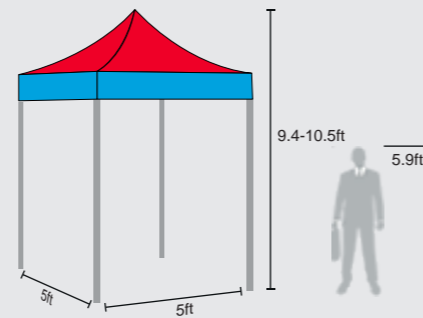

1.5x1.5m/5x5ft

Item	Hex40mm
Gross Weight	15kg/33lbs
Net Weight	13.8kg/29.1lbs
Package Size	160x26x26cm 63x10x10inch

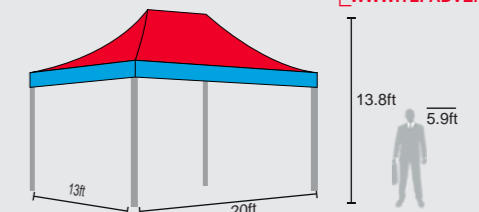

4x6m/13x20ft

Item	Hex50mm
Gross Weight	46kg/101.5lbs
Net Weight	44.5kg/98lbs
Package Size	203x35x46cm 80x13.7x18.1inch

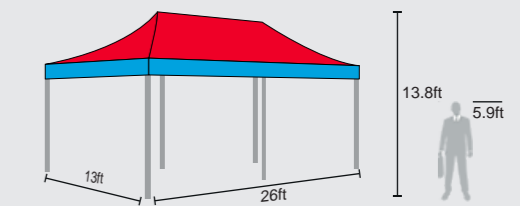

4x8m/13x26ft

Item	Hex50mm
Gross Weight	64kg/141lbs
Net Weight	62.3kg/137.4lbs
Package Size	203x35x60cm 80x13.7x23.6inch

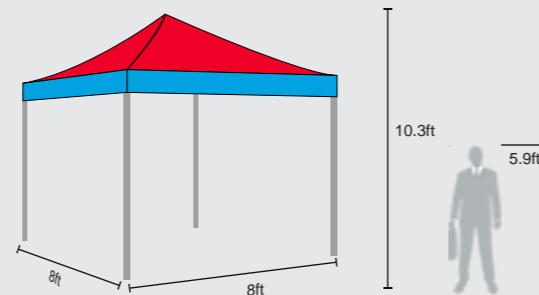

2.5x2.5m/8x8ft

Item	Hex40mm
Gross Weight	17kg/37.4lbs
Net Weight	15.8kg/34.9lbs
Package Size	160x26x26cm 63x10x10inch

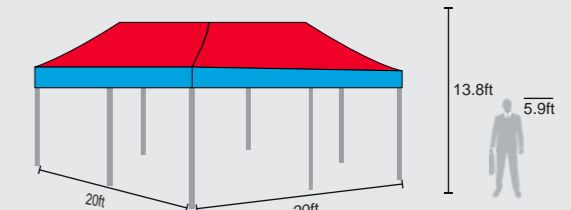

6x6m/20x20ft

Item	Hex50mm
Gross Weight	96kg/211.5lbs
Net Weight	94.2kg/207.7lbs
Package Size	160x60x60cm 63x23.6x23.6inch

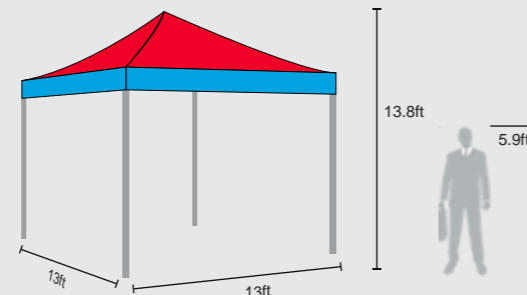

4x4m/13x13ft

Item	Hex50mm
Gross Weight	38kg/83.8lbs
Net Weight	36.5kg/80.5lbs
Package Size	203x33x33cm 80x12.9x12.9inch

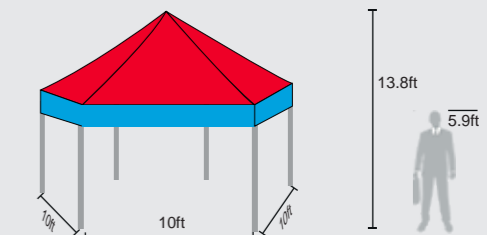

Hexagon Dia 3m/10ft

Item	Hex50mm
Gross Weight	57kg/125.7lbs
Net Weight	55.3kg/122lbs
Package Size	160x50x50cm 63x19.7x19.7inch

Hexagon

CUSTOMIZE TENT TOP

Customize size tent top and wall replacement for your own frames.

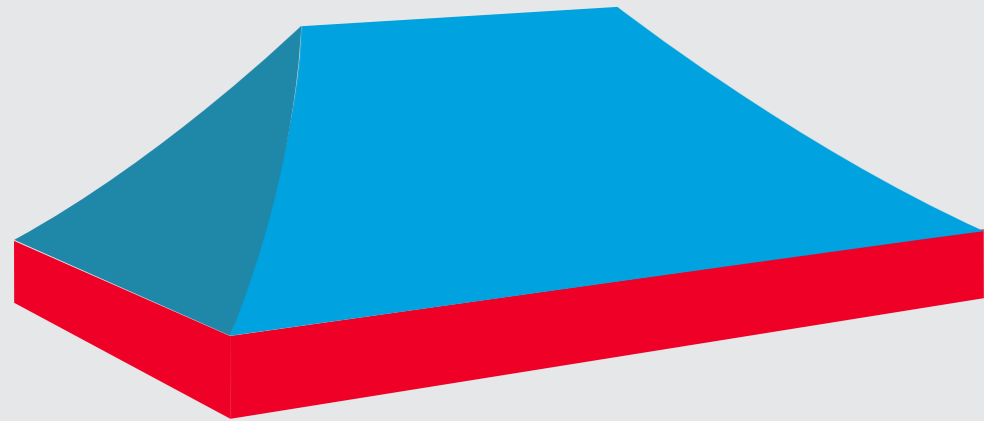

Tent Top Replacement
For Your Own Frame

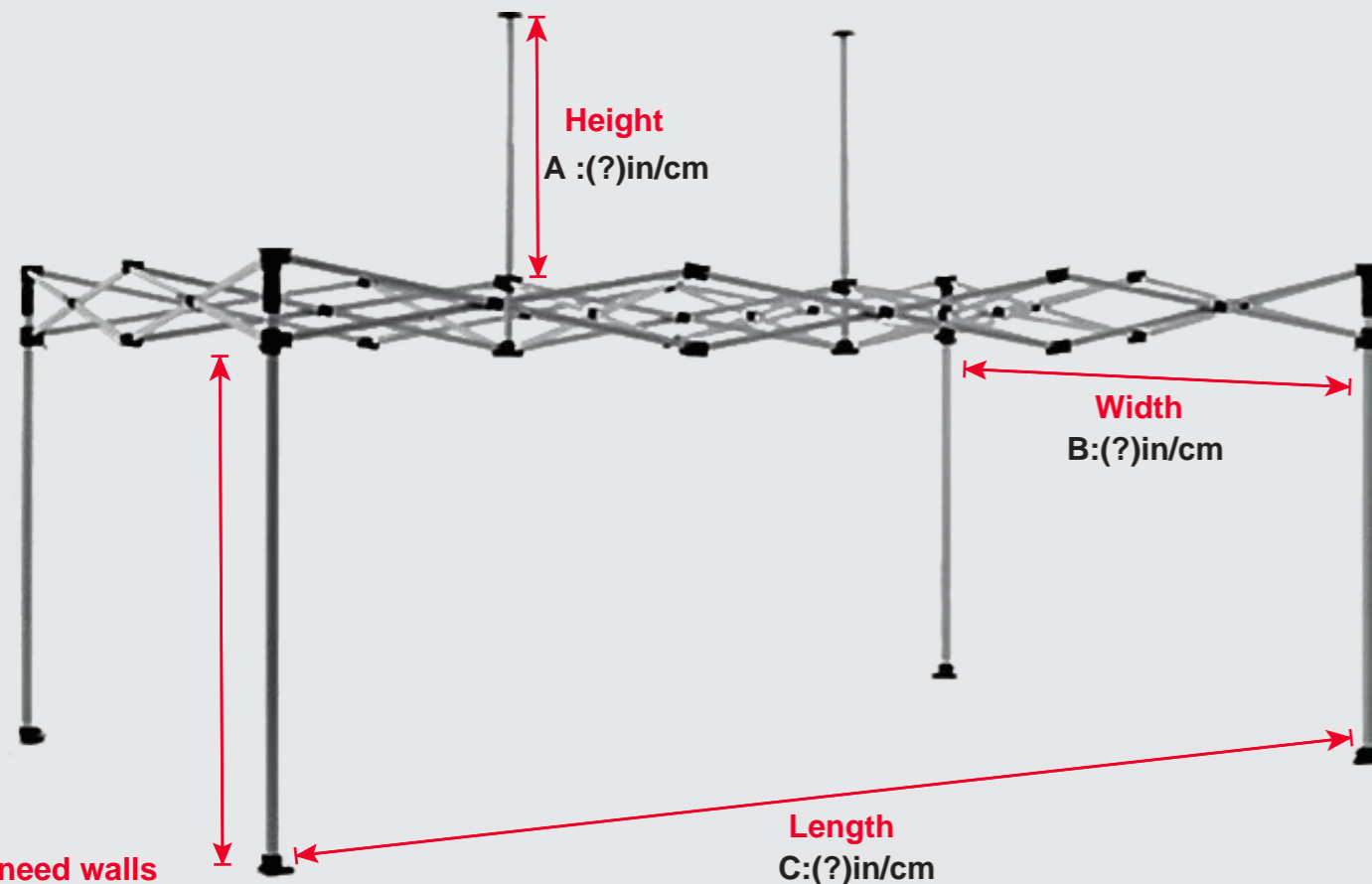

< Will need size A,B,C to make a perfect tent top for your own frame >

TENT ACCESSORIES



Wheeled Roller Bag



Weight Sand Bag



Foot Weight - Water Tank



Rain Gutter

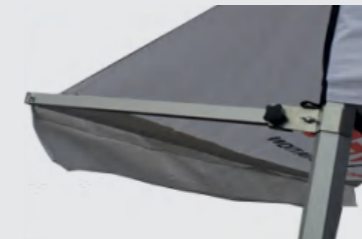

Front Awning



Foot Weight - Steel



Half Wall Bar And Clamp



Pegs And Rope



Tents Connectors

FLYING FLAGS

Custom Flying Flags are the most popular portable signs for both outdoor and indoor advertising. TLF make various flags and complete system to meet your advertising demand.



100% Fiberglass Flying Flag Pole

Black Color Pole System | One pole fit three shapes of flags

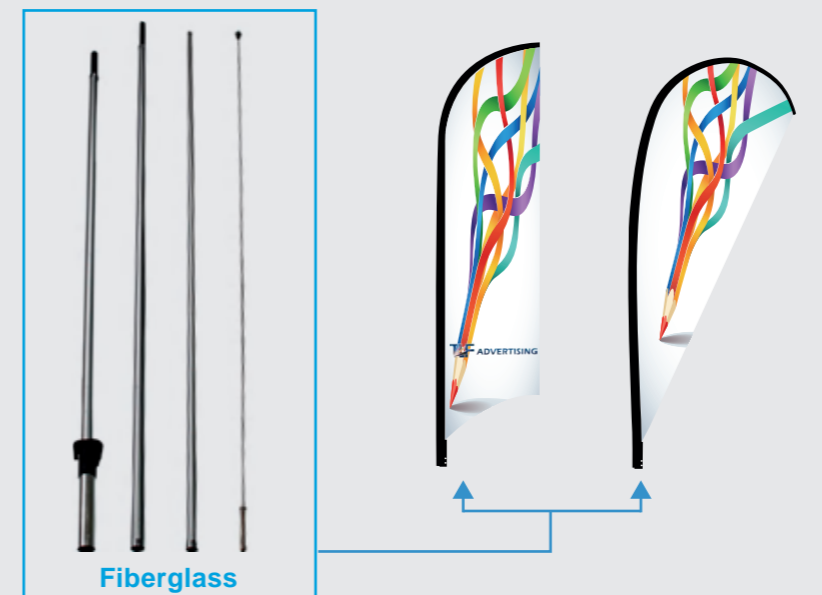
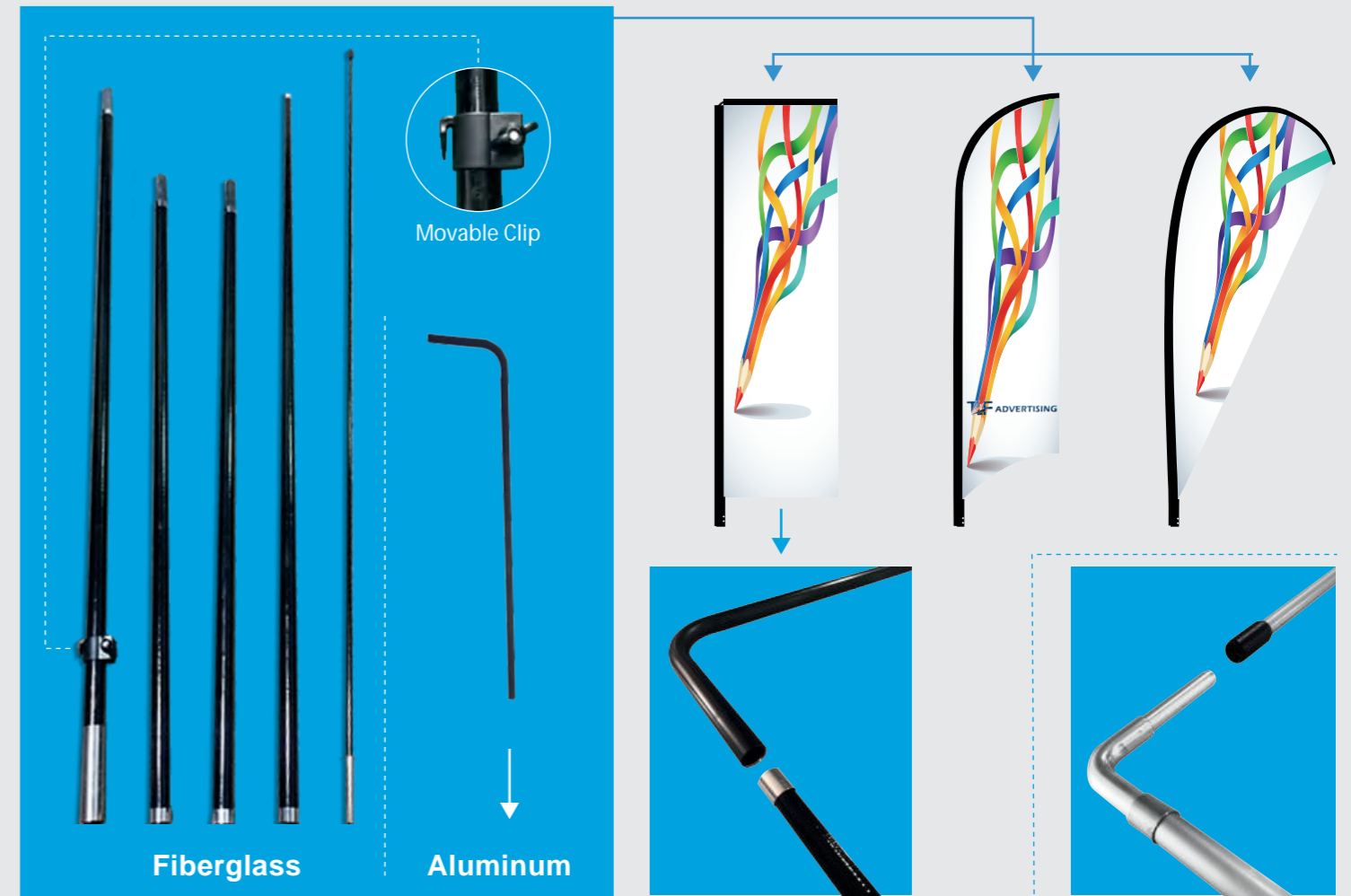

Silvery Color Pole System
One pole fit teardrop & feather flags

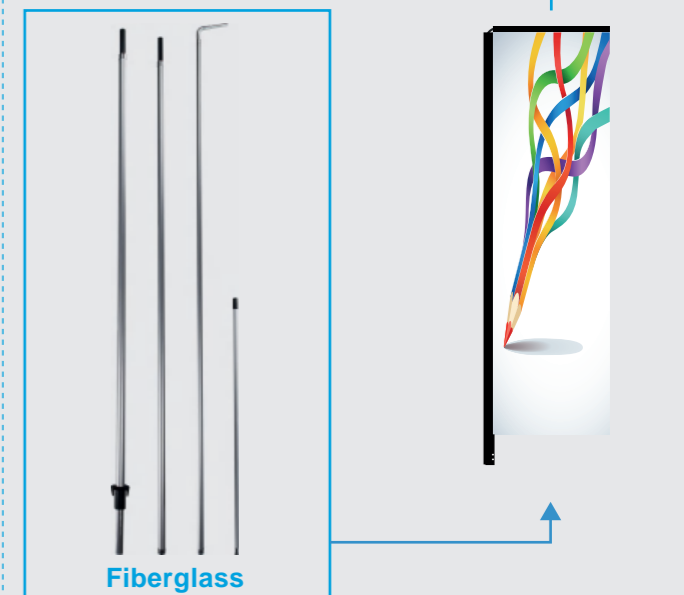

Silvery Color Pole System
For rectangular flag only

Standard sizes for feather flags and teardrop flags.

Standard sizes for rectangular flags.

Feather flag sizes

Optional shape

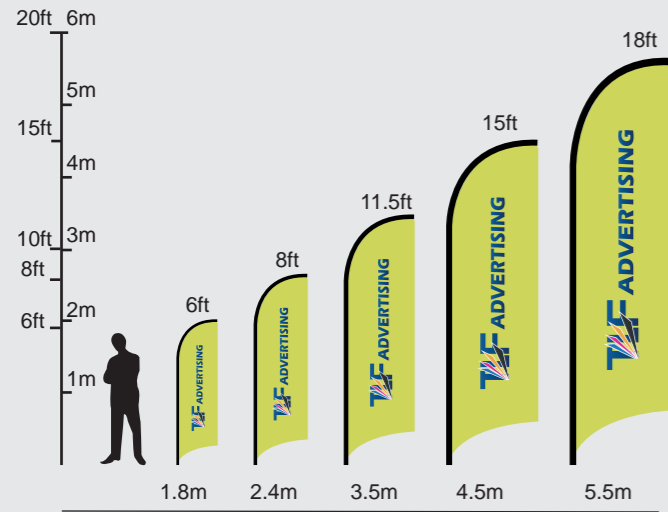

Teardrop flag sizes

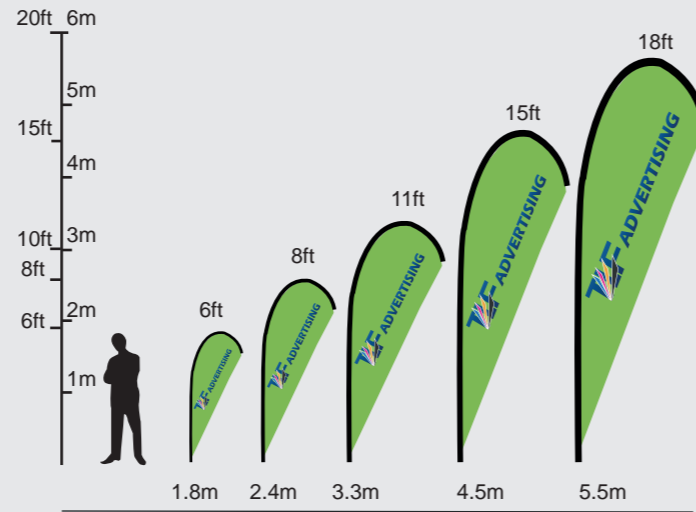

Rectangle flag sizes

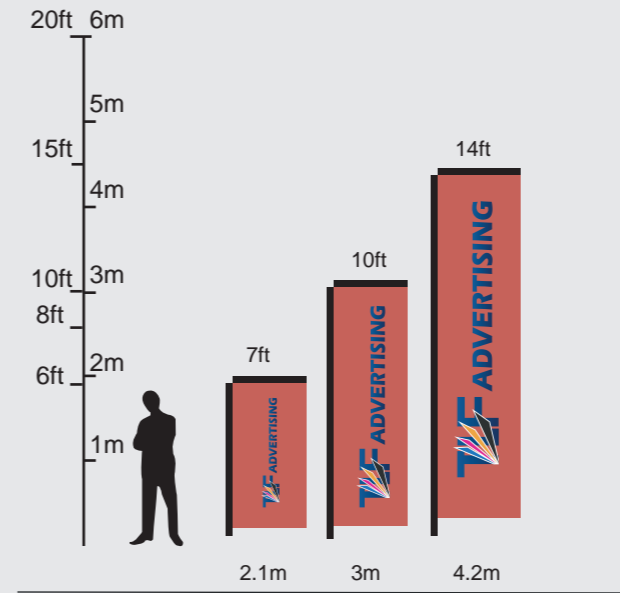

Silvery Pole

Rectangle flag sizes

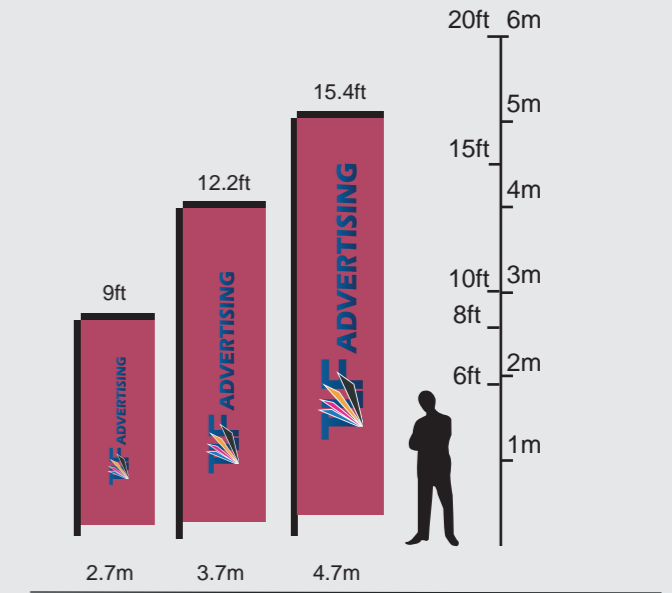

Black Pole

Feather Flag System Specification

Size	XS	S	M	L	XL
Height	1.8m/6ft	2.4m/8ft	3.5m/11.5ft	4.5m/15ft	5.5m/18ft
Black Pole	✓	✓	✓	✓	✓
Silvery Pole	✓	✓	✓	✓	✓
Graphic Size(cm/inch)	150x40/60x15.7	200x65/78.8x25	296x66/124x29.5	400x80/157.5x31.5	500x80/196.8x31.5
Packing Size(cm)	120x18x18/10pcs	154x17x17/10pcs	154x18x18/10pcs	154x20x20/10pcs	154x22x22/10pcs
Gross Weight(Kg)	7.5	8.5	9.5	12.5	18

Rectangle Flag System Specification

Size	S	M	L
Height	2.1m/7ft	3m/10ft	4.2m/14ft
Black Pole			
Silvery Pole	✓	✓	✓
Graphic Size(cm/inch)	70x168/27.5x66.1	70x250/27.5x98.5	70x345/27.5x135.8
Packing Size(cm)	120x18x18/10pcs	154x19x19/10pcs	154x20x20/10pcs
Gross Weight(Kg)	8.5	11	13.5

Teardrop Flag System Specification

Size	XS	S	M	L	XL
Height	1.8m/6ft	2.4m/8ft	3.3m/11ft	4.5m/15ft	5.5m/18ft
Black Pole	✓	✓	✓	✓	✓
Silvery Pole	✓	✓	✓	✓	✓
Graphic Size(cm/inch)	118x50/46.5x19.5	175x74/69x29	266x110/104.7x43.3	347x130/136.6x51.2	457x124/179.9x48.8
Packing Size(cm)	120x18x18/10pcs	154x17x17/10pcs	154x18x18/10pcs	154x20x20/10pcs	154x22x22/10pcs
Gross Weight(Kg)	7.5	9	11.5	15	18

Rectangle Flag System Specification

Size	S	M	L
Height	2.7m/9ft	3.7m/12.2ft	4.7m/15.4ft
Black Pole	✓	✓	✓
Silvery Pole			
Graphic Size(cm/inch)	70x210/27.5x82.6	70x310/27.5x122	70x420/27.5x165
Packing Size(cm)	154x18x18/10pcs	154x19x19/10pcs	154x20x20/10pcs
Gross Weight(Kg)	12	15	18

FLAGS

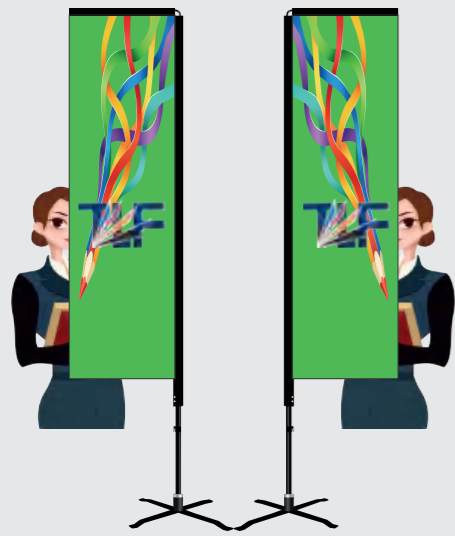

Double sides flag is 2 printed graphics sewn back to back. Image reading correctly both sides

Single sided flag that has a mirror image on the opposite side, it is transparent.

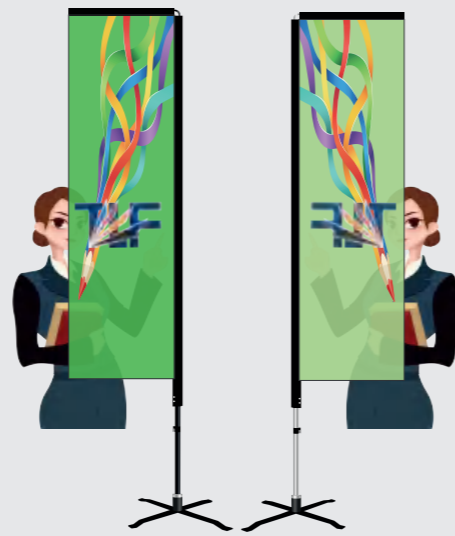

Back Side Front Side
Double Sides Flag

Back Side Front Side
Single Side Flag

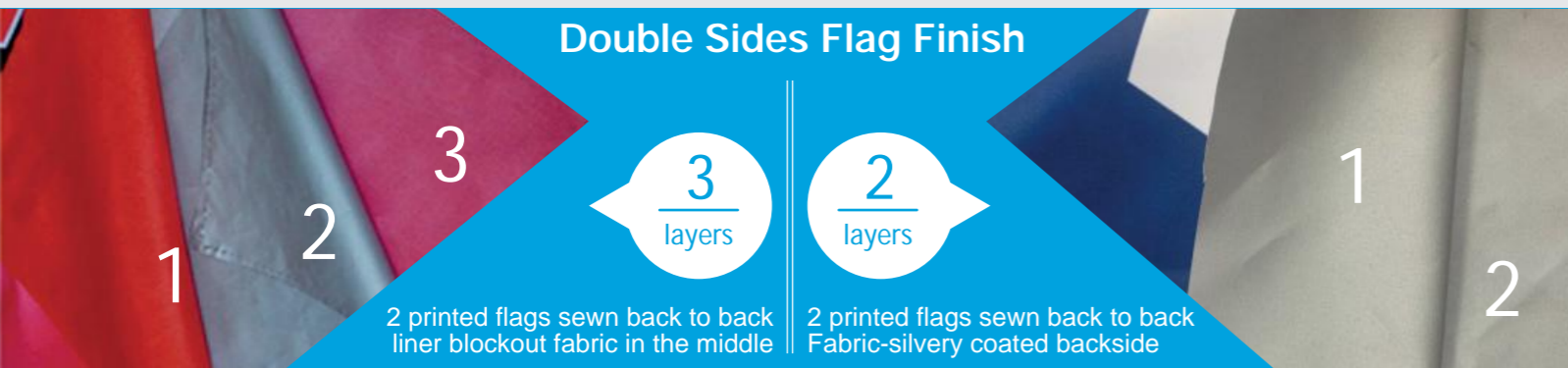

Double Sides Flag Finish

- 1 2 printed flags sewn back to back
- 2 liner blockout fabric in the middle
- 3 2 printed flags sewn back to back Fabric-silvery coated backside

Thick Oxford Cloth Sleeve

Thick black oxford sleeve
White and printed sleeve are available

Nylon Lanyard

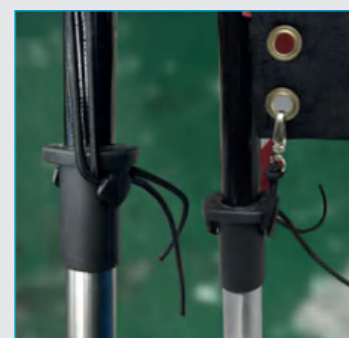

(3 layers)
Reinforced at top of sleeve

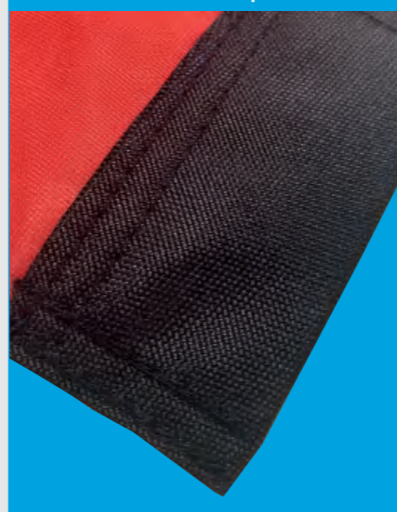

FLAG BASES

Various flagpole bases use on pavement ground, soft land, wall, tent etc.

Flag Bases



Flag Bases Series Specification

Base Code	ba-1	ba-2	ba-3	ba-4	ba-5	ba-6
Net Weight	1kg/2.2lbs	1.2kg/2.6lbs	3.8kg/8.3lbs	3.2kg/7lbs	1.8kg/4lbs	5.8kg/12.8lbs 7.8kg/17.2lbs 10.8kg/23.8lbs
Base Code	ba-7	ba-8	ba-9	ba-10	ba-11	ba-12
Net Weight	0.8kg/1.8lbs	1.35kg/3lbs	2.3kg/5lbs	1.2kg/2.6lbs	0.9kg/2lbs	0.3kg/0.66lbs

Backpack flags are the ideal mobile product to complement any marketing campaign. The flags are worn as a backpack, allowing for constant mobility and customer engagement. They provide the perfect channel to promote your product or service and are ideal for any indoor or outdoor event.

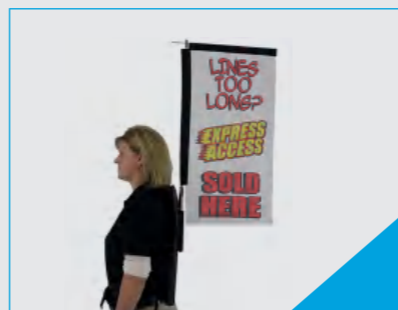
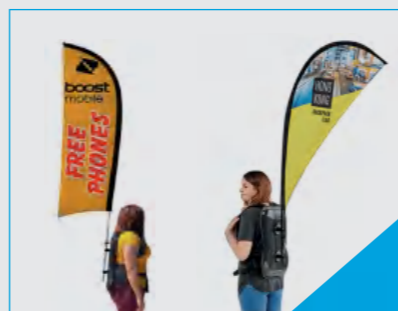

Thicker fabric



Delicate sewing, breathable fabrics



Buckle



ABS connector, stronger and durable, tenacious

Backpack Flag System Specification

Shape	Feather	Teardrop	Rectangle
Backpack N.W(kg)	1.3	1.3	1.3
Pole Length(cm)	210	210	125cm
Graphic Size(cm/inch)	51x122/20x48	52x103/20.5x40.5	40x80/15.8x31.5
Packing Size(cm)	60x50x40 5pcs/ctn	60x50x40 5pcs/ctn	60x50x40 5pcs/ctn
Gross Weight(Kg)	7.5	7.5	7.5

Various flags for advertising.

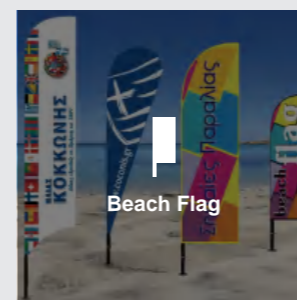

Beach Flag

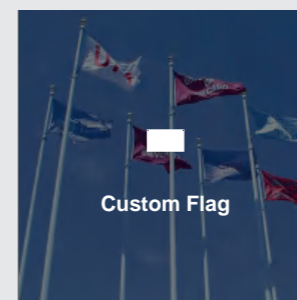

Custom Flag

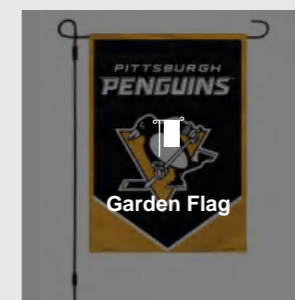

Garden Flag

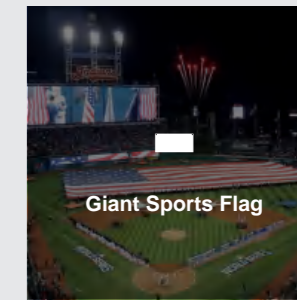

Giant Sports Flag

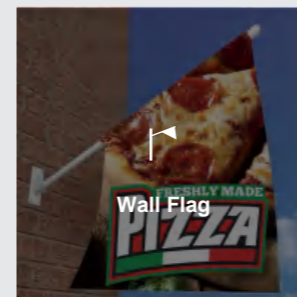

Wall Flag

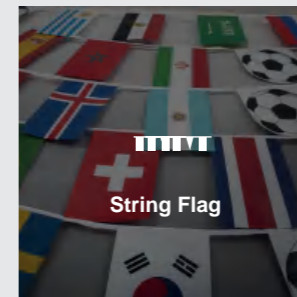

String Flag

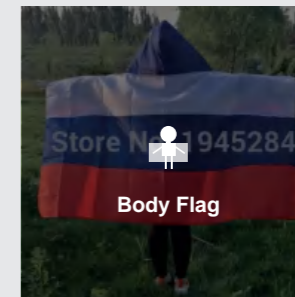

Body Flag



Hand Flag

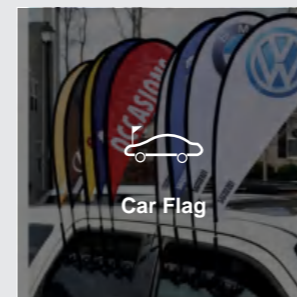

Car Flag

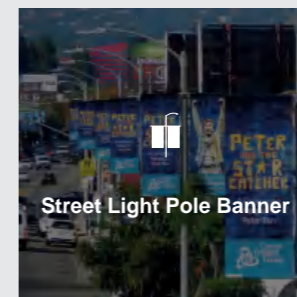

Street Light Pole Banner

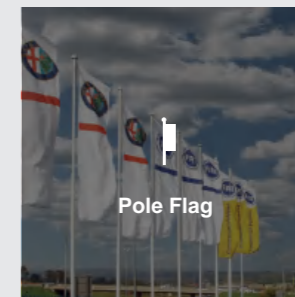

Pole Flag

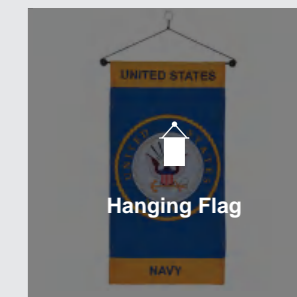

Hanging Flag

Popular Finish For Custom Flags

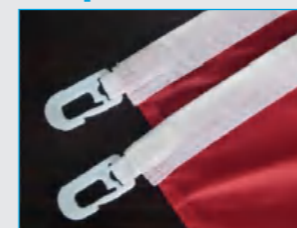

Rectangle Plastic Hook



D Plastic Hook



Suspender Buckles

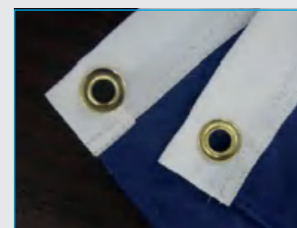

Brass Grommets

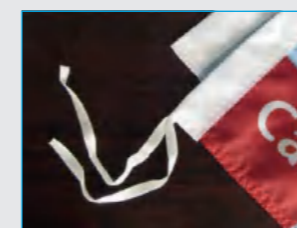

Rope At Bottom

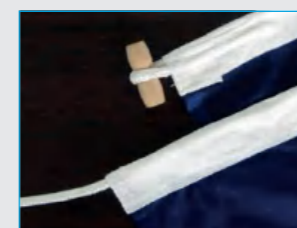

Toggle And Rope

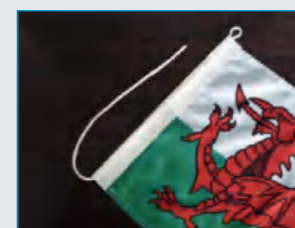

Loop And Rope

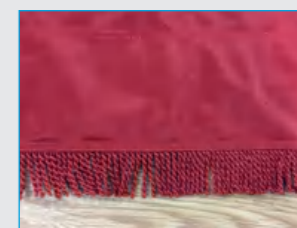

Tassel Trim

INFLATABLE SERIES

Sealed air advertising inflatables are the most easy-carry sign for outdoor, lightweight, no electricity needed, no continuous air blowing needed.

Inflatable Tent



Zigzag Sewing Over Pressure Valve Leg Center LED Light System YKK Zip Durable PVC Bottom

Tent Legs Color Options

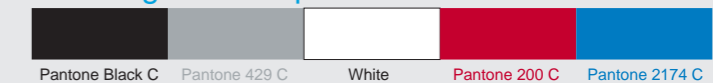

Air Tent 3x3m
TSA0303



Air Tent 4x4m
TSA0404



Air Tent 5x5m
TSA0505



Air Tent 6x6m
TSA0606

3x3m/10x10ft Sealed Air Tent

Item	TSA0303
Entrance Height(m/ft)	1.9/6.24
Size(L*W*H)m/ft	3.2x3.2x2.4/10.5x10.5x8
Packing Size(cm/in)	60x51x38/23.6x20x15 walls not included
Weight(kg/lbs)	17/37.5 walls not included

4x4m/13x13ft Sealed Air Tent

Item	TSA0404
Entrance Height(m/ft)	2/6.56
Size(L*W*H)m/ft	3.95x3.95x2.7/13x13x9
Packing Size(cm/in)	60x51x38/23.6x20x15 walls not included
Weight(kg/lbs)	22/48.5 walls not included

5x5m/16x16ft Sealed Air Tent

Item	TSA0505
Entrance Height(m/ft)	2.5/8.2
Size(L*W*H)m/ft	4.85x4.85x3.3/16x16x11
Packing Size(cm/in)	60x55x47/23.6x21.6x18.5 walls not included
Weight(kg/lbs)	27/59.5 walls not included

6x6m/20x20ft Sealed Air Tent

Item	TSA0606
Entrance Height(m/ft)	3/10
Size(L*W*H)m/ft	5.8x5.8x3.9/19x19x13
Packing Size(cm/in)	75x65x60/29.5x25.6x23.6
Weight(kg/lbs)	37/81.6 walls not included

INFLATABLE ARCH AND COLUMN

Custom size inflatable arch and column are welcome.

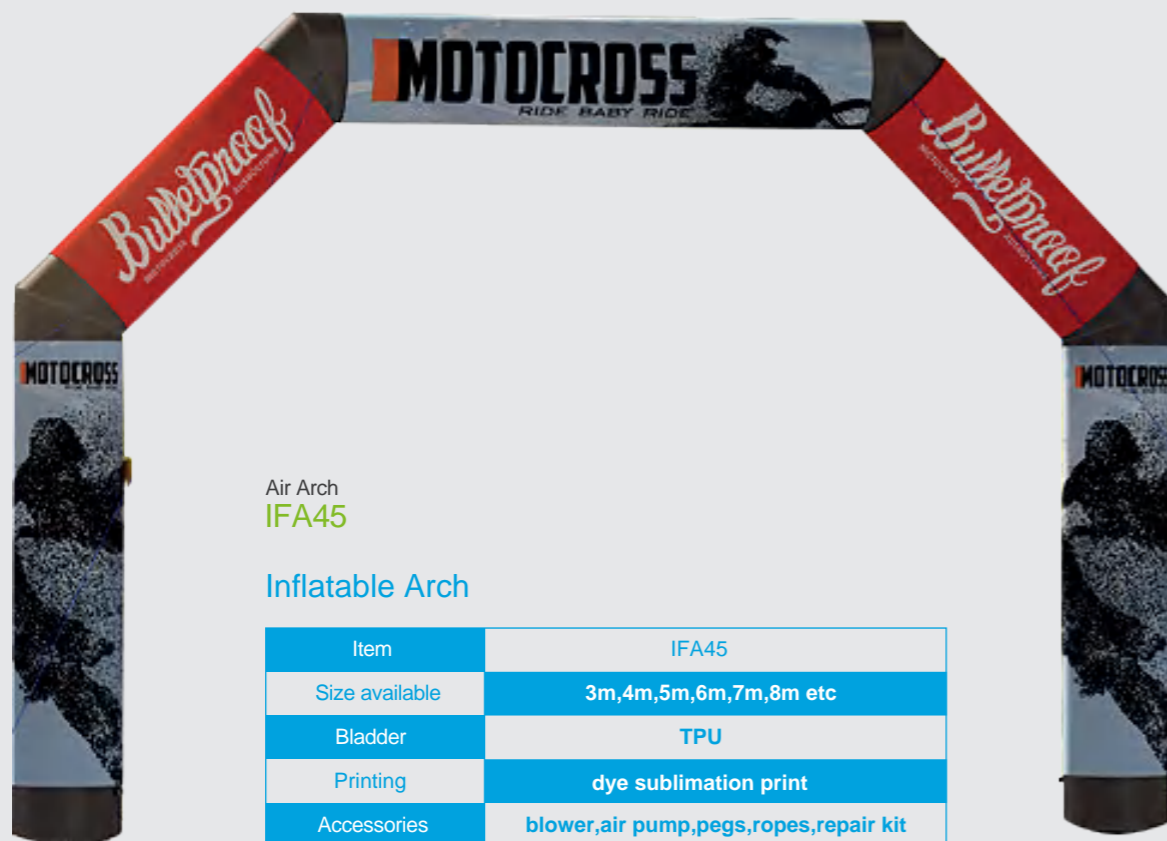

Air Arch
IFA45

Inflatable Arch

Item	IFA45
Size available	3m,4m,5m,6m,7m,8m etc
Bladder	TPU
Printing	dye sublimation print
Accessories	blower,air pump,pegs,ropes,repair kit

INFLATABLE FURNITURE



Air Chair
SAF01

Inflatable Chair

Item	SAF01
Size	76x95x80cm 30x37.4x31.5inch
Components	TPU bladder,printed fabric cover LED optional



Air Ottoman
SAF02

Inflatable Ottoman

Item	SAF02
Size	68x68x38cm 26.6x26.6x15inch
Components	TPU bladder,printed fabric cover LED optional

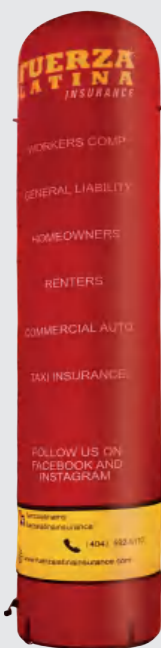

Inflatable Tube
SAF04

Inflatable Tube

Item	SAF04					
Size(cm)/Height x Dia	200Hx45D	250Hx45D	280Hx60D	300Hx45D	400Hx45D	500Hx45D

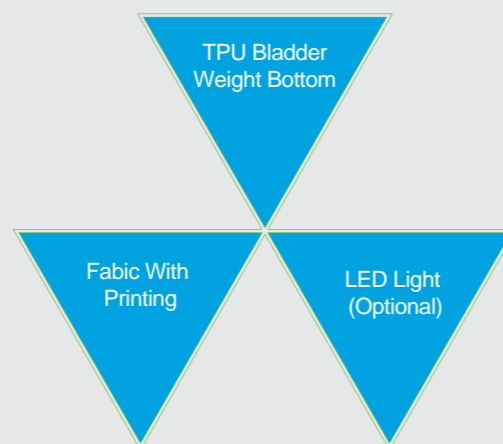

Air Table
SAF03

Inflatable Table

Item	SAF03
Size	100x85x42cm 39.4x33.4x16.5inch
Components	TPU bladder,printed fabric cover LED optional



BARRIER STAND

Barrier stand can be a crowd-control barrier, also an advertising sign. Widely used in sports field, shop front, street, public area, shopping mall etc.

TWO OPTION

Steel frame with PVC banner.
Mainly used in cafe shop front, street, restaurant, shopping mall etc.

Aluminum frame with fabric/mesh banner or fabric pillow case.
Mainly used in sports field, street, shopping mall etc.

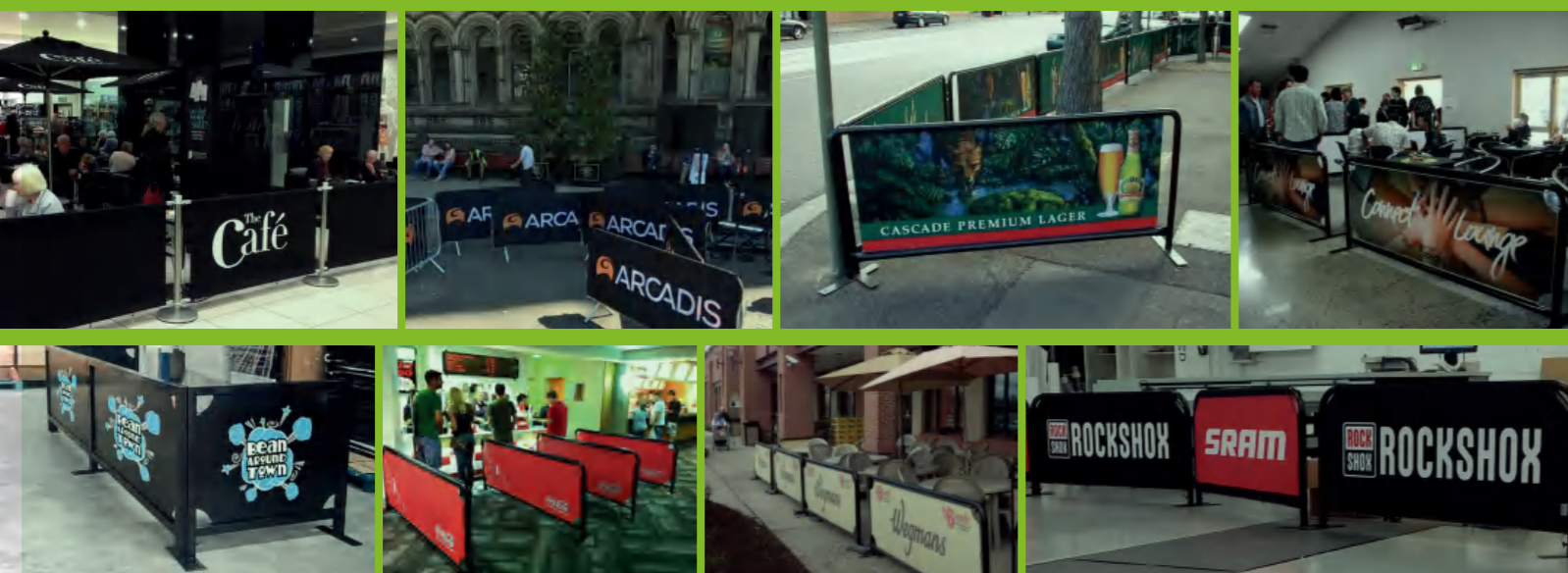

Aluminum Frame With Fabric Pillow Case
TB-WL10

Aluminum Frame With Fabric Pillow Case

DIMENSIONS

Item	TB-WL10		
Size	100x90/39.4x35.4 cm/inch	150x90/59x35.4 cm/inch	200x90/78.7x35.4 cm/inch
Packing Details	65*22*16cm/1set/4.5kg/ctn	65*22*18cm/1set/5kg/ctn	65*22*20/1sets/6kg/ctn



Round Steel Tube Stand With PVC Banner
TB-WL20

Round Steel Tube Stand With PVC Banner

DIMENSIONS

Item	TB-WL20		
Size	100x90/39.4x35.4 cm/inch	150x90/59x35.4 cm/inch	200x90/78.7x35.4 cm/inch
Packing Details	103*95*7cm/1sets/10kg/ctn	153*95*7cm/1sets/13kg/ctn	203*95*7/1sets/16kg/ctn



Square Steel Tube With PVC Banner
TB-WL21

Square Steel Tube With PVC Banner

DIMENSIONS

Item	TB-WL21		
Size	100x90/39.4x35.4 cm/inch	150x90/59x35.4 cm/inch	200x90/78.7x35.4 cm/inch
Packing Details	103*95*7cm/1set/10kg/ctn	153*95*7/1set/13kg/ctn	203*95*7cm/1sets/16kg/ctn

POP OUT BANNER

The Pop Out Banner is a quick and easy way to promote your business or event. The banner display unfolds in seconds and is ready to go. No tools are required for display assembly. Simply unfold the panels and connect them with the hook-and-loop tape strips.

POP OUT BANNER



Oval/Horizontal Pop Out Banner
PP01



Vertical Pop Out Banner
PP02



Circle Pop Out Banner
PP03



Triangle Pop Out Banner
PP04



Tower Pop Out Banner
PP05

Oval/Horizontal Pop Out Banner

DIMENSIONS

Item	PP01 Oval/Horizontal		
Graphic Size	70x120cm/ 27.5x47inch	100x200cm/ 39x78inch	110x260cm/ 43x102inch
Packing Details	42x35x42cm/ 10sets/21kg/ctn	62x35x62cm/ 5sets/20.5kg/ctn	63x35x63cm/ 5sets/37kg/ctn

Vertical Pop Out Banner

DIMENSIONS

Item	PP02 Vertical		
Graphic Size	60x90cm/ 23.6x35.4inch	100x175cm/ 39.4x69inch	125x200cm/ 49x78.7inch
Packing Details	42x35x42cm/ 10sets/20kg/ctn	62x35x62cm/ 10sets/26kg/ctn	72x35x72cm/ 10sets/37kg/ctn

Circle Pop Out Banner

DIMENSIONS

Item	PP03 Circle		
Graphic Size	100x100cm/ 39x39inch	120x120cm/ 47x47inch	150x150cm/ 59x59inch
Packing Details	42x35x42cm/ 10sets/21kg/ctn	62x35x62cm/ 10sets/26kg/ctn	75x35x75cm/ 10sets/37kg/ctn

Triangle Pop Out Banner

DIMENSIONS

Item	PP04 Triangle		
Graphic Size	100x100cm/ 39x39inch	120x120cm/ 47x47inch	150x150cm/ 59x59inch
Packing Details	42x35x42cm/ 10sets/21kg/ctn	62x35x62cm/ 10sets/26kg/ctn	75x35x75cm/ 10sets/37kg/ctn

Tower Pop Out Banner

DIMENSIONS

Item	PP05 Tower		
Graphic Size	70x120cm/ 27.5x47inch	100x200cm/ 39x78inch	110x260cm/ 43x102inch
Packing Details	42x42x42cm/ 10sets/25kg/ctn	62x30x62cm/ 5sets/28kg/ctn	62x35x62cm/ 3sets/30kg/ctn



INDOOR

SHANGHAI TLF ADVERTISING CO.,LTD

TLF
ADV
RTIS
ING



Indoor trade show displays are designed to help turn heads and attract attention at any expo or promotional event.

A great and successful booth design oozes professionalism and is an instant draw for attendees.

When it comes to promoting your brand, we believe there's always room to grow.

STRAIGHT WALL SERIES

Tension fabric straight wall series including standard sizes and a large number of custom sizes. Standard size including 8ft, 10ft, 13ft, 16ft, 20ft.



20ft Straight
TB-11W14



10ft Straight
TB-11W14

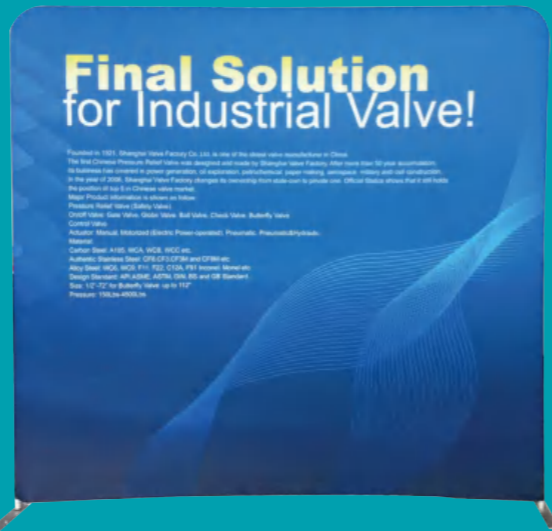

8ft Straight
TB-11W14

CURVED WALL SERIES

Curved series display assembles easily with snap & click poles, no feet needed. Standard size: 8ft, 10ft, 20ft.



20ft Curved
TB-11W15



10ft Curved
TB-11W15



8ft Curved
TB-11W15

Component Schematic

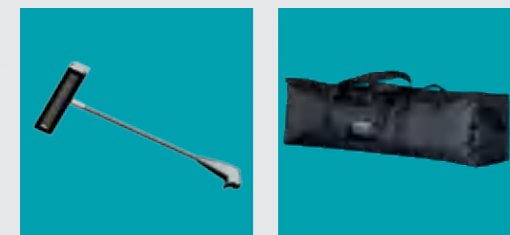
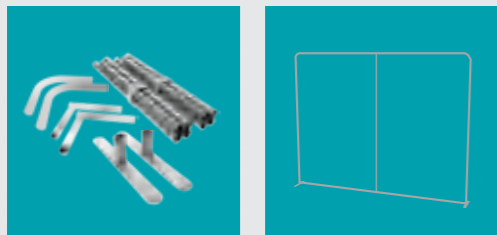

Straight Wall Series Specification

Item	TB-11W14		
Frame size(mm)	8ft Straight 8ft 2438x2280	10ft Straight 10ft 2922x2280	20ft Straight 20ft 5960x2280
Graphic Size(mm)	2448x2280	2930x2280	5960x2280
Gross Weight(Kg)	9.8	10.9	20.8
Packing Size(cm)	27x27x74	27x27x74	37.5x37.5x76

More Standard Dimension Available

Item	TB-11W14				
Frame Size (mm)	1000x1000	5000x1000	3000x1500	2000x2280	1000x2500
	1500x1000	6000x1000	4000x1500	2500x2280	1500x2500
	2000x1000	1000x1500	5000x1500	3000x2280	2000x2500
	2500x1000	1500x1500	6000x1500	4000x2280	1000x3000
	3000x1000	2000x1500	1000x2280	5000x2280	1500x3000
	4000x1000	2500x1500	1500x2280	6000x2280	2000x3000

Component Schematic

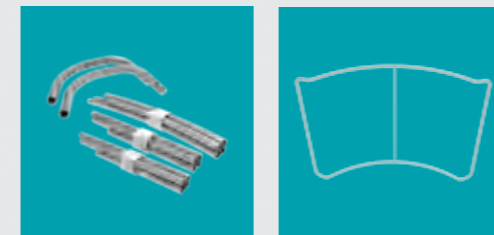

Curved Wall Series Specification

Item	TB-11W15		
Frame size(mm)	8ft Curved 8ft 2438x2280	10ft Curved 10ft 3000x2280	20ft Curved 20ft 5960x2280
Graphic Size(mm)	2560x2280	3150x2280	6150x2280
Weight(Kg)	8	10.2	17
Packing Size(cm)	27x27x74	27x27x74	37x37x87

More Standard Dimension Available

Item	TB-11W15		
Frame Size (mm)	4000x2280	5000x2280	6000x2280

U-SHAPED WALL SERIES

U-shaped series use the design of the support legs to stand, and overall more stable display rack. The upper and lower cambered effect. The design allows the screen to form



20ft U-Shaped
TB-11W16



10ft U-Shaped
TB-11W16



8ft U-Shaped
TB-11W16

S-SHAPED WALL SERIES

S-shaped wall series including standard straight and oblique s-shaped categories, including standard straight 8ft, 10ft, 20ft; oblique S-type size 10ft, 20ft, without foot, can be combined into exhibition standard solutions, exible, simple and elegant.

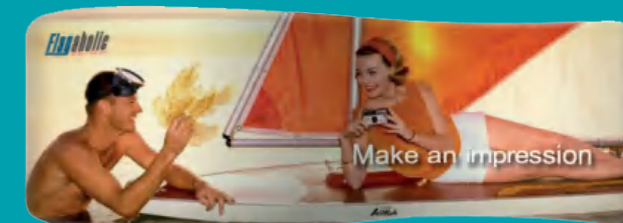

20ft S-Shaped
TB-11W17



10ft S-Shaped
TB-11W17



8ft S-Shaped
TB-11W17

Component Schematic



U-Shaped Series Specification

Item	TB-11W16		
Frame size(mm)	8ft U- Shaped 8ft 2430×2280	10ft U- Shaped 10ft 2750×2280	20ft U- Shaped 20ft 6000×2280
Graphic Size(mm)	2490×2280	2780×2280	6040×2280
Gross Weight(Kg)	8.8	9.8	20.4
Packing Size(cm)	27×27×87	27×27×87	37×37×104

More Standard Dimension Available

Item	TB-11W16			
Frame Size (mm)	1000×1000	2000×1000	3000×1000	5000×1000
	1500×1000	2500×1000	4000×1500	6000×2280

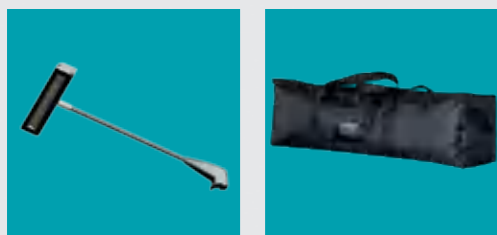

Component Schematic

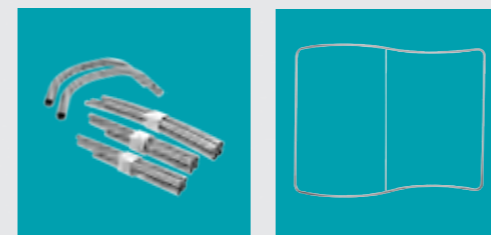

S-Shaped Wall Series Specification

Item	TB-11W17		
Frame size(mm)	8ft S- Shaped 8ft 2438×2280	10ft S- Shaped 10ft 2997×2280	20ft S- Shaped 20ft 5960×2280
Graphic Size(mm)	2684×2280	3140×2280	6360×2280
Gross Weight(Kg)	8.9	10	18.8
Packing Size(cm)	27×27×74.5	27×27×88	37×37×80

More Standard Dimension Available

Item	TB-11W17		
Frame Size (mm)	3000×2280	4000×2280	5000×2280



C-SHAPED WALL SERIES

C-shaped wall series use curved design without foot, it is a stylish backdrop to display your graphic. Standard sizes are 8ft, 10ft, 20ft.



20ft C-Shaped
TB-11W18



10ft C-Shaped
TB-11W18



8ft C-Shaped
TB-11W18

Component Schematic

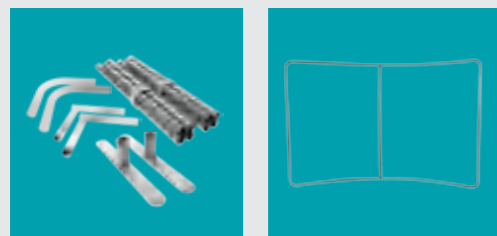

C-Shaped Wall Series Specification

Item	TB-11W18		
Frame size(mm)	8ft C- Shaped 8ft 2750×2280	10ft C- Shaped 10ft 2980×2280	20ft C- Shaped 20ft 5960×2280
Graphic Size(mm)	2780×2280	3280×2280	6540×2280
Gross Weight(Kg)	9.7	10.2	19
Packing Size(cm)	27×27×87	37×37×80	37×37×92

More Standard Dimension Available

Item	TB-11W18		
Frame Size (mm)	3000×1000	3000×1500	3000×2280
	4000×1000	4000×1500	4000×2280
	5000×1000	5000×1500	5000×2280

OVERLAP SHAPED SERIES

Overlap shape wall series are a great alternative to standard backwall displays, tool-free connecting with the front panels and no hurt on graphic. Quickly assembled in just 5 minutes, slide the tubes together to make the frame and lock in place with a push button snap. Then, simply pull the pillowcase-like graphic over the frame and zip it shut. The zipper, hidden from view, tightens the stretch fabric beautifully displaying your image. Disassembled, this lightweight frame and graphic fits inside its included bag.



TB-11W14+ Z08+Z08



Z08



TB-11W14



TB-11W14+Z08

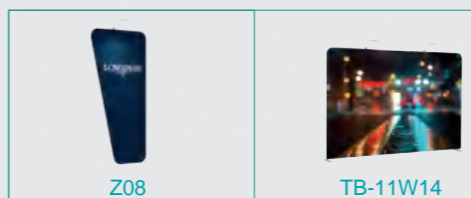

Z08

TB-11W14



TB-11W14+Z08

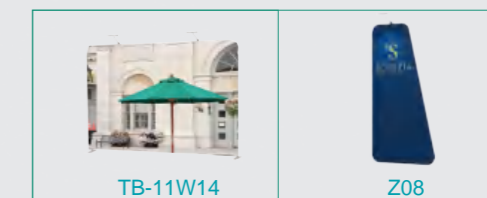

TB-11W14

Z08

Overlap Shaped Wall Series Specification

Item	TB-11W14		Z08
Frame size(mm)	10ft 2922×2280	20ft 5960×2280	716/1274×2438
Graphic Size(mm)	2930×2280	5960×2280	716/1274×2438
Gross Weight(Kg)	10.9	20.8	7
Packing Size(cm)	27×27×74	27×27×74	37×37×74

Application series comes with the different shaped walls and different front attachment, tool-free connecting and no hurt on graphic. We have a wide range of stands and shelving systems, made to combine with your stretch fabric displays. Unless specified, which make the whole stand more elegant and multifunctional.



20ft U-Shaped Application
TB-11W16+Z02



20ft Straight Application
TB-W14+Z01

10ft Straight Application
TB-W14+Z03



10ft Straight Application
TB-W14+Z04



Holder
TB-07R04



Supporting Shelf
TB-07R05

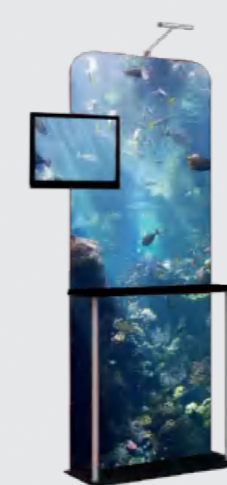

Component Schematic

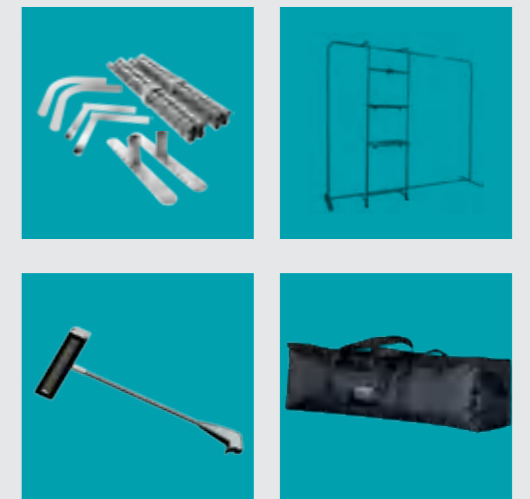

Application Series Specification

Item	TB-11W16+Z02	TB-W14+Z01	TB-W14+Z04	TB-W14+Z03
Frame size(mm)	20ft 6000×2280	20ft 5965×2280	10ft 2922×2280	10ft 2922×2280
Graphic Size(mm)	6040×2310	5965×2280	2930×2280	2930×2280
Gross Weight(Kg)	45	44.6	19.2	21.2
Packing Size(cm)	37×37×74 38×18×83×2	38×37×74 38×18×83×2	27×27×74 38×18×83	27×27×74 38×18×83

Application Series Specification

Item	TB-07R04	TB-07R05
Frame size(mm)	Holder	Supporting Shelf
Graphic Size(mm)	910×2280	960×2290
Gross Weight(Kg)	26	21
Packing Size(cm)	98×14×40	98×14×40

Semi-Circle series use semi-circle shaped design, a stylish solution to your meeting or reception space needs.



Semi-Circle Stand A
TB-11W22



Semi-Circle Stand D
TB-11W21



Semi-Circle Stand B
TB-11W20



Semi-Circle Stand C
TB-11W19

Semi-Circle Stand Specification

Item	TB-11W22	TB-11W20	TB-11W19	TB-11W21
Frame size(mm)	Semi-Circle Stand A 3000×2280/1219	Semi-Circle Stand B 2980×2280	Semi-Circle Stand C 3000×2280	Semi-Circle Stand D 6000×2280
Graphic Size(mm)	6950×2300/1219	4980×2300	4680×2340	9300×2290
Gross Weight(Kg)	18.5	18.8	19.4	30.7
Packing Size(cm)	37×37×81	27×27×97	37×37× 74	37×37×74

Component Schematic



3D BACK WALL

3D wall series are a unique backdrop for booth design. Various concave make your booth more attractive.

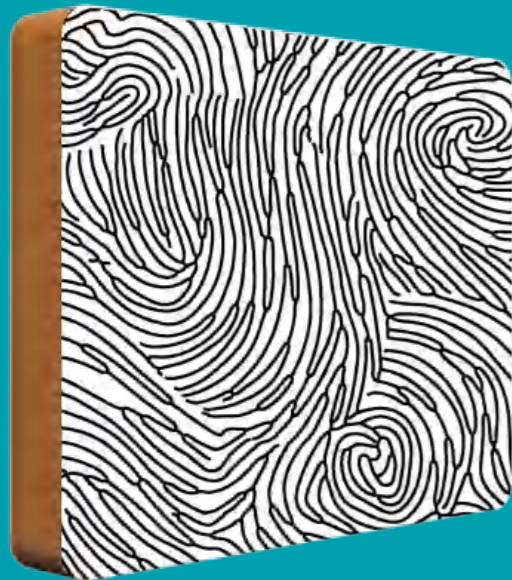

3D Backwall A
TB-10D04



Concave Series-Square
TB-10D07



Concave Series-Round
TB-10D06

3D Backwall B
TB-10D05



3D Back Wall Specification

Item	TB-10D04	TB-10D05	TB-10D06	TB-10D07
Frame size(mm)	3000x2400x400	4500x2400x400	5960x2500	5960x2500
Graphic Size(mm)	3040x2440	4540x2440	6000x2540	6000x2540
Gross Weight(Kg)	13.6	20.5	44.4	43.5
Packing Size(cm)	36.5x36.5x88.5	36.5x36.5x88.5	131x81x30	131x81x30

Component Schematic



3D MOON WALL

3D moon series are designed in full/half moon-shape, unique stand for exhibition or advertising events.



3D Semi-Moon Rack
TB-10D03



3D Moon
TB-10D01



Double 3D Semi-Moon Rack
TB-10D02

Our fabric moon stands are unique and effective branding solution. As part of our stretch fabric range, these stands are made up of two main components a strong lightweight frame and a fully printed 'stretch' fabric.

Component Schematic



3D Moon Specification

Item	TB-10D03	TB-10D02	TB-15D01
Frame size(mm)	3D Semi-Moon Rack 1330x2280x400	Double 3D Semi-Moon Rack 1330x2280x400x2	3D Moon 2500x2200x400
Graphic Size(mm)	1300x2280	1300x2280x2	2500x2200x400
Gross Weight(Kg)	17.5	28	12.5
Packing Size(cm)	26.5x26.5x87	26.5x26.5x87x2	36.5x36.5x87

Fabric pop up display is classic portable backdrop sign for exhibition or photo graphic booth. Easy and quick to setup and take down. One man, no tools, take only a few second to set up your booth easily.



10ft Straight Pop Up Displays
TB-S10

Component

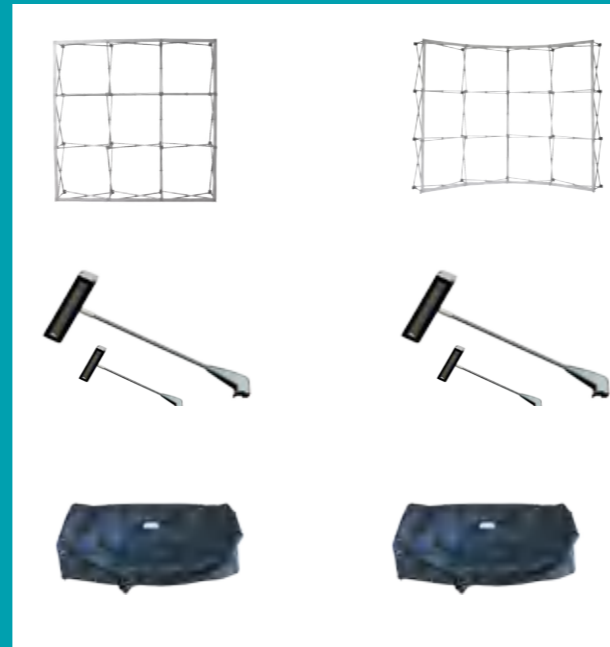

Schematic



10ft Curved Pop Up Display
TB-C10

8ft Straight Pop Up Displays
TB-S08



8ft Straight Pop Up Displays
TB-S08



8ft Curved Pop Up Display
TB-C08



8ft Curved Pop Up Display
TB-C08



Pop Up Display Series Specification

Item	TB-S08		TB-S10	
Frame size	225x225cm/89x89inch		300x225cm/119x89inch	
Graphic Size	225x225cm/89x89" no sides	300x225cm/119x89" with sides	300x225cm/119x89" no sides	370x225cm/145.5x89" with sides
Gross Weight	12.1kg/26.7lbs	12.5kg/27.6lbs	14kg/30.8lbs	14.6kg/32.2lbs
Packing Size	31x31x85cm 12.2x12.2x33.5"	31x31x85cm 12.2x12.2x33.5"	31x38x85cm 12.2x15x33.5"	31x38x85cm 12.2x15x33.5"

Pop Up Display Series Specification

Item	TB-C08		TB-C10	
Frame size	200x225cm/79x89inch		270x225cm/106x89inch	
Graphic Size	209x225cm/82x89"	272x225cm/107x89"	277x225cm/109x89"	340x225cm/134x89"
Gross Weight	12.1kg/26.7lbs	12.5kg/27.6lbs	14.6kg/32.2lbs	15.2kg/33.5lbs
Packing Size	31x31x85cm 12.2x12.2x33.5inch	31x31x85cm 12.2x12.2x33.5inch	31x38x85cm 12.2x15x33.5inch	31x38x85cm 12.2x15x33.5inch

ADJUSTABLE BANNER

Adjustable banner stand is a fantastic backdrop stand for recycling use. Easy and quick to adjust the sizes according to your graphic sizes.



Adjustable Banner Stand
TB-WN0510

Pole pocket at top and bottom
Banner solution A



Adjustable Banner Stand
TB-WN0510

Grommets on graphic, tied on frame
Banner solution B

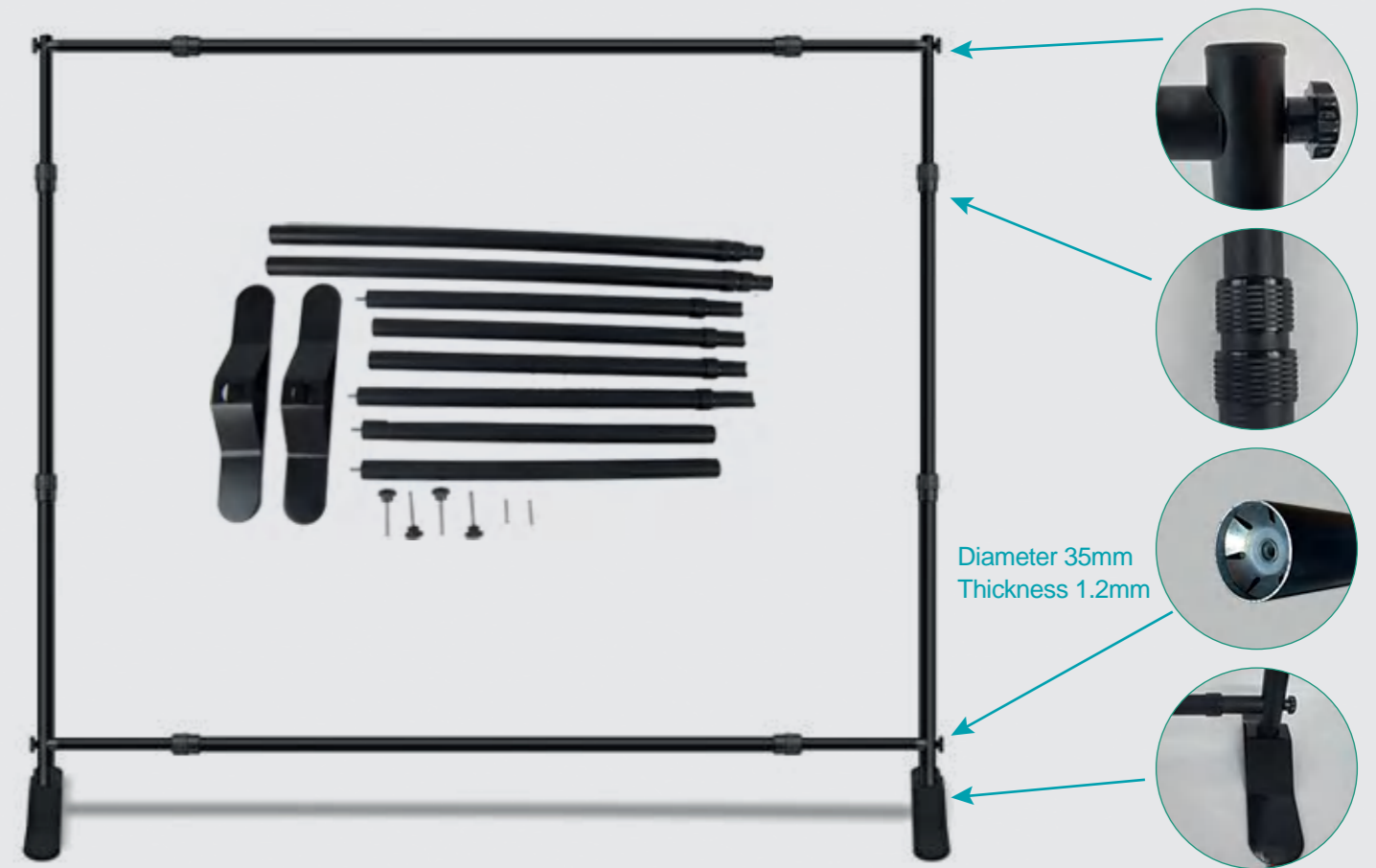

Adjustable Banner Series Specification

Item	TB-WN0510	
Frame size	Width:155-305cm/61x121inch	Height:107-247cm/42x97inch
Graphic Size	Width:150-300cm/59-118inch	Width:102-243cm/40-95.5inch
Gross Weight	8.5kg/18.7kg(frame with bag only)	
Packing Size	102x26x12cm 40x10.3x4.72inch	

COUNTER SERIES

Counter series use aluminum tube poles support up and down panel, stretch fabric screen used to connect the upper and lower panels to form the front desk, various shapes and can be used for exhibitions or reception.



Triangle Counter

TB-06C2



Oval Counter
TB-06C1



Square Counter
TB-06C3



Folding Square Counter
TB-06C4



Round Bar Counter
TB-06C5

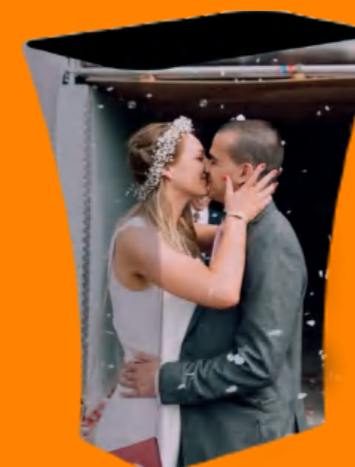

Square Bar Counter
TB-06C6



Long Oval Counter
TB-06C7

Component Schematic



Counter Series Specification

Item	TB-06C1	TB-06C2	TB-06C3	TB-06C4	TB-06C5	TB-06C6	TB-06C7
Frame size(mm)	Oval 595×396×1010	Triangle 600×600×1010	Square 800×530×1010	Folding Square 1950×520×1010	Round 700/500×1010	Square 800×500/600×400×1010	Long Oval 720×330×990
Graphic Size(mm)	1480×1025	1880×1025	2200×1025	4640×1025	2160×1130	2410×1150	1700×1020
Gross Weight(Kg)	8	11.2	11.1	28.3	14.7	10.8	9
Packing Size(cm)	66×11×45	63×11×63	83×11×58	103×14×56×2	72×12×78	87×12×59	39×15×78

DISPLAY RACK SERIES

Display rack series use the the tube pole support up and down panel extending out put acrylic shelves, stretch fabric screen used to connect the upper and lower panels to form a display shelf, is designed to be simple and compact, can be used for exhibitions or shopping malls display.



Backwall Display Rack
TB-07R01



Backwall Display Rack With Header
TB-07R02



Oval Display Rack
TB-06C1R



Triangle Display Rack
TB-06C2R



Square Display Rack
TB-06C3R



Triangle Promotion Counter
TB-06C1H



Oval Promotion Counter
TB-06C2H



Square Promotion Counter
TB-06C3H

Display Rack Series Specification

Item	TB-07R01	TB-07R02
Frame size(mm)	Backwall Display Rack 930×450×1980	Backwall Display Rack With Header 930×450×2015
Graphic Size(mm)	840×1380/2600×600	840×1380/2600×600
Gross Weight(Kg)	19.3	20.3
Packing Size(cm)	97×14×48	97×14×48

Component Schematic

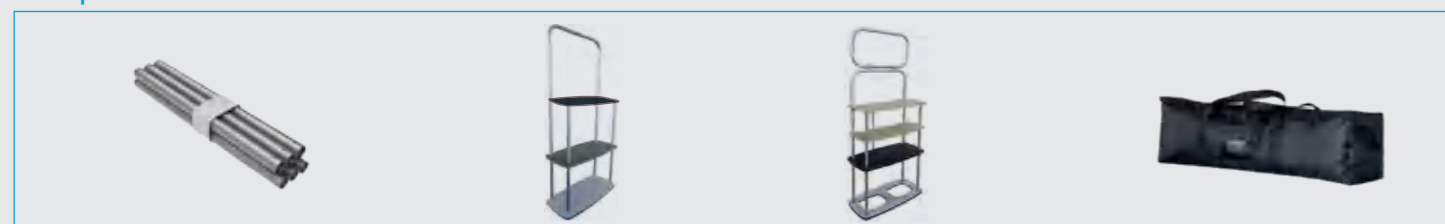

Display Rack Series Specification

Item	TB-06C1R	TB-06C2R	TB-06C3R	TB-06C1H	TB-06C2H	TB-06C3H
Frame size(mm)	Oval 595×396×1928	Triangle 600×600×1928	Square 800×530×1928	Triangle Promotion Counter 600×600×1950	Oval Promotion Counter 595×395×1950	Square Promotion Counter 800×530×1950
Graphic Size(mm)	1480×1025	1880×1025	2200×1025	1880×1025	1480×1025	2200×1025
Gross Weight(Kg)	14	17.2	23.6	12.3	9.1	13.5
Packing Size(cm)	66×19×45	65×13×65	84×15×57	63×11×63	66×11×45	83×11×58

COLUMN

Column can be your good island advertising choice for exhibition or shopping mall sales, small space with four sided graphics.



Morning Glory
TB-17C04



TB-17C03



TB-17C02



Colum Stand
TB-17C05



Colum Stand
TB-17C06



TB-17C01



TB-17C02+DH11



TB-17C01+DH12

Column Series Specification

Item	TB-17C04	TB-17C03	TB-17C02
Frame size(mm)	Φ 3000/1200×3300	Φ 1524×3048	Φ 1524×3048
Graphic Size(mm)	6910×3160×3140	4785×3048	4785×3048
Gross Weight(Kg)	33	23.8	23.8
Packing Size(cm)	36.5×36.5×132	38×36×88	38×36×88

Component Schematic

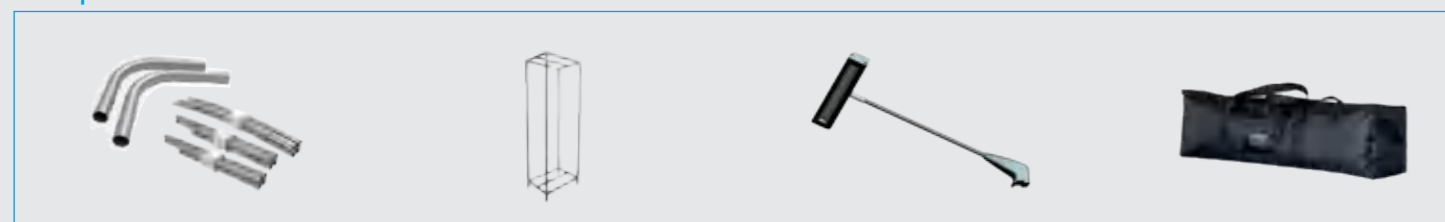

Column Series Specification

Item	TB-17C05	TB-17C06	TB-17C01	TB-17C02+DH12	TB-17C07+DH11
Frame size(mm)	500×700×2000	800×800×3000	1016×3048×400	1016×3048×400	1219×1219×3657/ Φ 3048×1219
Graphic Size(mm)	2400×2000	3200×3000	1046×3068	1046×3068	1219×3657×4/ 9570×1219
Gross Weight(Kg)	6.7	9.9	13.5	19	43.5
Packing Size(cm)	27×27×74	30×30×82	28×28×99	36×37×104	54×34×131

SNAKE DISPLAY SERIES

Snake stands are easy fabric signs which widely used in exhibition and shopping mall advertising.



Snake Stand
TB-08S02



Snake Stand
TB-08S01



Snake Stand
TB-08S03



Snake Stand
TB-08S04



Snake Stand
TB-08S05

Snake Display Series Specification

Item	TB-08S01	TB-08S02	TB-08S03	TB-08S04	TB-08S05
Frame size(mm)	915x228	915x228	915x228	915x228	915x228
Graphic Size(mm)	940x2400	940x3520	940x3050	940x3140	940x3350
Gross Weight(Kg)	6.7	7.2	7.5	6.5	7.6
Packing Size(cm)	24x18x78	35x19x81	33x16x80	33x16x80	33x16x80

Component Schematic

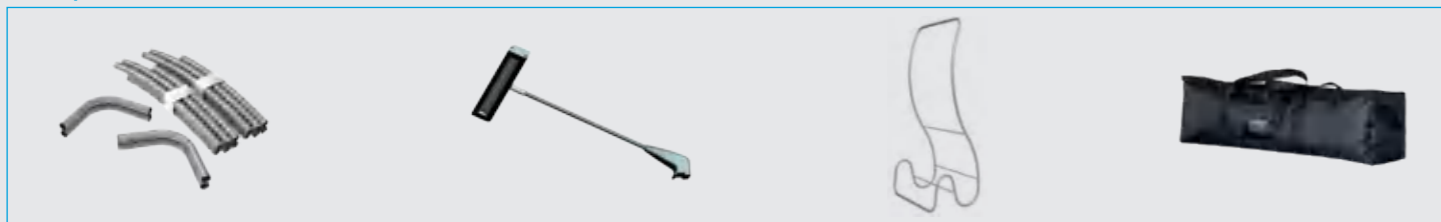

IPAD STAND

Pad can be assembled on these stand easily, catalogues can be placed on its holders.



Pad Stand
TB-08P01



Pad Stand
TB-08P03



Pad Stand
TB-08P04

Pad Stand Series Specification

Item	TB-08P01	TB-08P03	TB-08P04
Frame size(mm)	380x1300	380x1255	380x1320
Graphic Size(mm)	410x1880	430x1370	410x1880
Gross Weight(Kg)	4	8	3
Packing Size(cm)	35x18x83	48x17x50	64x12x36

Component Schematic

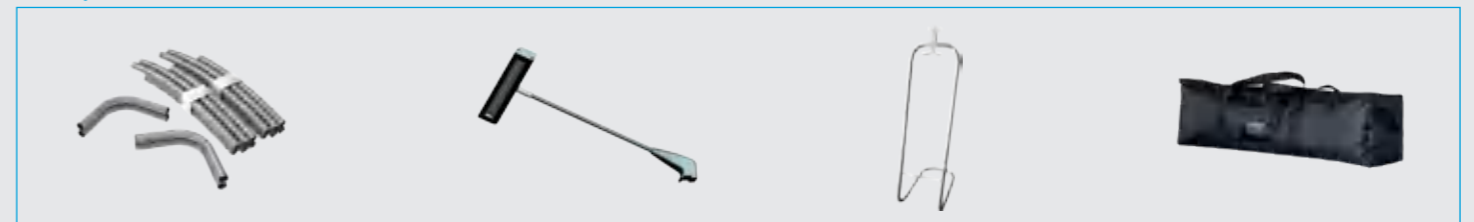

SEG MODULAR LIGHTBOX

SEG modular light stand is a toolless configurable portable LED lightbox stand, Magnetic Dany-Snap electrical connection, easy to set up and carry.

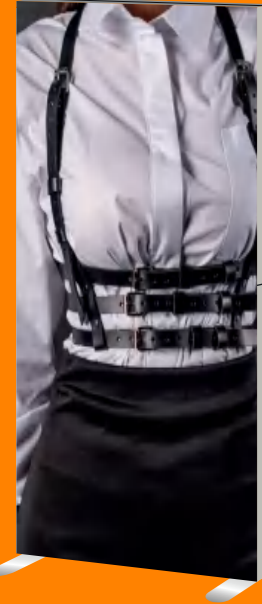

85x200cm
SEG-SD01



100x200cm
SEG-SD01



200x200cm
SEG-SD01



300x200cm
SEG-SD01



100x100cm
SEG-LC01

**Pre-installed Hardware
For Toolless Setup**

**SEG Modular
Backlit Display
Features**

**Magnetic LED
Strip Connectors**

**Recessed Feet To Eliminate
Gaps Between Displays**

SEG Modular Lightbox Specification

Item	SEG-SD01				SEG-SD01
	850x2000	1000x2000	2000x2000	3000x2000	1000x1000
Frame size(mm)	850x2000	1000x2000	2000x2000	3000x2000	1000x1000
Graphic Size(mm)	850x2000	1000x2000	2000x2000	3000x2000	1000x1000
Gross Weight(Kg)	12.1/1ctn	12.5 /1ctn	19.1/2ctns	23.3/2ctns	12.9/2ctns
Packing Size(cm)	116x18x40	116x18x40	116x18x40	116x17x40	116x18x40

More Standard Dimension Available

Item	SEG-SD01			
	850x1500	1000x1000	2000x2250	3000x2250
Frame size(mm)	850x2250	1000x1500	2000x2500	3000x2500
	850x2500	1000x2250		
		1000x2500		

Component Schematic



TUBE BANNER STANDS

ECONOMY TUBE BANNER STANDS



TB-11S16

Economy tube banner stands with slim steel feet includes 24", 30", 31.5", 33.5", 36", 48", 60" etc different width to meet different kinds of demands, which can replace roll up banners to avoid the graphic not quite straight issues, which is also much stable and elegant.



Premium tube banner stands with steel feet includes 24", 30", 31.5", 33.5", 36", 48", 60", 79", 96", 120", 10 different width to meet different kinds of demands, which can replace retractable banners to avoid the graphic not quite straight issues, which is also much stable and elegant.



TB-11S17

PREMIUM TUBE BANNER STANDS

Premium tube banner stands with steel base includes 24", 30", 36", 48", 60" 5 different width to meet different kinds of demands, which can replace retractable banners to avoid the graphic not quite straight issues, which is also much stable and elegant.

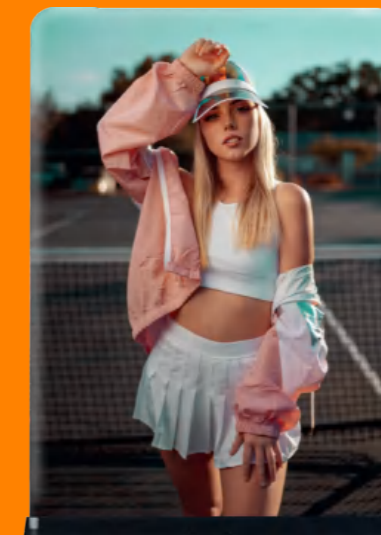
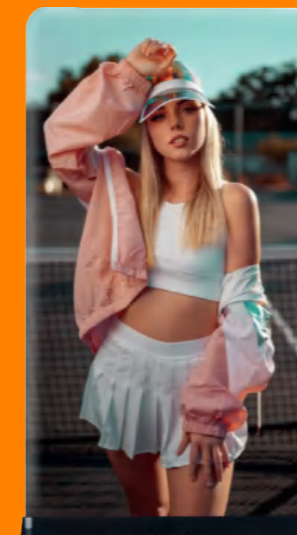
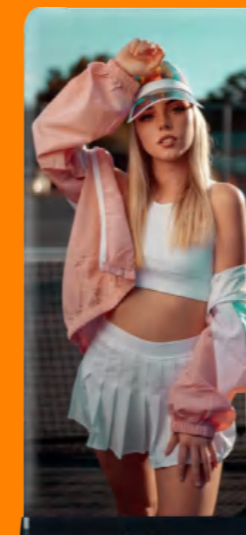
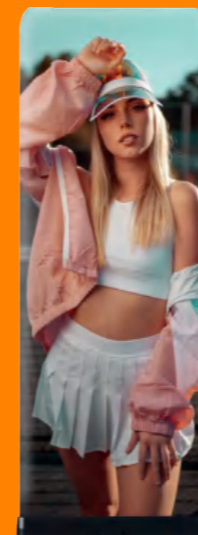

TB-11S18

Premium Tube Banner Stands Specification

Item	TB-11S18			
Frame size(mm)	24"612x2280	36"917x2280	48"1222x2280	60"1526x2280
Graphic Size(mm)	642x2290	947x2290	1252x2290	1556x2290
Gross Weight(Kg)	7.8	10.1	12.5	17
Packing Size(cm)	29x11.5x72	28x10x100	29x10x128	29x11x161

Economy Tube Banner Stands Specification

Item	TB-11S16							
Frame size(mm)	24" 612x2280	30" 762x2280	31.5" 800x2280	33.5" 850x2280	36" 917x2280	48" 1222x2280	60" 1526x2280	
Graphic Size(mm)	650x2330	800x2330	840x2330	900x2330	960x2330	1270x2330	1570x2330	
Gross Weight(Kg)	3.75	4.5	4.9	5.1	5.7	7	8.9	
Packing Size(cm)	11.5x11.5x79	11.5x11.5x79	11.5x11.5x90	11.5x11.5x90	16.5x11.5x90	16.5x11.5x84	16.5x11.5x84	

Premium Tube Banner Stands Specification

Item	TB-11S17										
Frame size(mm)	24" 612x2280	30" 762x2280	31.5" 800x2280	33.5" 850x2280	36" 917x2280	48" 1222x2280	60" 1526x2280	79" 2000x2280	96" 2438x2280	120" 2922x2280	
Graphic Size(mm)	652x2290	802x2290	840x2290	890x2290	957x2290	1262x2290	1566x2290	2040x2290	2478x2290	2962x2290	
Gross Weight(Kg)	4.6	5.2	5.4	5.7	6	6.5	7.3	8.3	9.8	10.9	
Packing Size(cm)	24.5x18.5x77	24.5x18.5x77	24.5x18.5x77	24.5x18.5x77	24.5x18.5x77	26.5x 26.5x74	26.5x 26.5x74	26.5x 26.5x74	26.5x 26.5x74	26.5x 26.5x74	



TB-11S19

Premium Tube Banner Stands Specification

Item	TB-11S19		
Frame size(mm)	24"612x2280	30"762x2280	36"917x2280
Graphic Size(mm)	inner vinyl:450x2050 Outer Fabric:642x2290	inner vinyl:600*2050 Outer Fabric:792*2290	inner vinyl:755*2050 Outer Fabric:947*2290
Gross Weight(Kg)	6.3 6.7	6.9 7.5	8.5 9.1
Packing Size(cm)	84x26.5x8.5	84x26.5x8.5	100x26.5x8.5

BANNER STAND DISPLAY

Roll up banner stand is the perfect portable banner stand for trade show or shop promotions.

Roll-up banners are perfect for displaying advertisements where the public can see them. They also make a huge impact in your shop or place of business as a point of sale material.



Roll UP Stand
TRB3



Roll Up Stand
TRB6



Roll Up Stand
TRB6

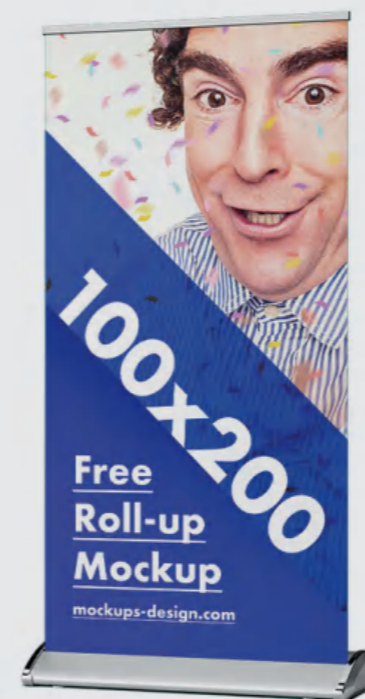

Roll Up Stand
TRB8

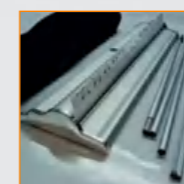

Roll Up Stand
TRB11

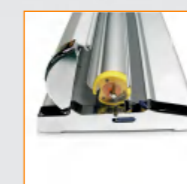

Desk Roll Up Stand
Mini



TRB3 Series Specification

Item	TRB3	
Size	200x80cm/79x31.5inch	200x85cm/79x33.5inch
Graphic Size	200x80cm/79x31.5inch	200x85cm/79x33.5inch
Net Weight	2.8kg/6.2lbs	3kg/6.6lbs
Packing Size	85x22x46cm 10pcs/ctn	90x22x46cm 10pcs/ctn

TRB6 Series Specification

Item	TRB6	
Size	200x80cm/79x31.5inch	200x85cm/79x33.5inch
Graphic Size	200x80cm/79x31.5inch	200x80cm/79x31.5inch
Net Weight	5.3kg/11.7lbs	5.6kg/12.4lbs
Packing Size	85x22x46cm 5pcs/ctn	90x22x46cm 5pcs/ctn

TRB8 Series Specification

Item	TRB8	
Size	200x80cm/79x31.5inch	200x85cm/79x33.5inch
Graphic Size	200x80cm/79x31.5inch	200x85cm/79x33.5inch
Net Weight	4.5kg/9.9lbs	4.75kg/10.4lbs
Packing Size	85x22x46	90x22x46

TRB11 Series Specification

Item	TRB11	
Size	200x80cm/79x31.5inch	200x85cm/79x33.5inch
Graphic Size	200x80cm/79x31.5inch	200x85cm/79x33.5inch
Net Weight	4.3kg/9.5lbs	4.6kg/10.2lbs
Packing Size	85x22x46cm 4pcs/ctn	90x22x46cm 4pcs/ctn

Mini Rollup Series Specification

Item	Mini	
Frame size	A3 (42x30cm/16.5x11.8inch)	A4 (30x21cm/11.8x8.3inch)
Graphic Size	42x30cm/16.5x11.8inch	30x21cm/11.8x8.3inch
Weight	0.34kg/0.75lbs	0.25kg/0.55lbs
Packing Size	45x35x46 50pcs/ctn	45x35x46 50pcs/ctn

HANGING CEILING SIGNS

Hanging ceiling signs are the best for trade shows. Not just a head above, these custom hanging ceiling banners can effortlessly attract audience miles away.

Available in round, square, and triangle configurations as well as numerous sizes, there is a Hanging ceiling sign that would suit almost any.



Circle (1220x310mm)
TB-12H01



Circle (1830x510mm)
TB-12H01



Circle (3000x510mm)
TB-12H01



Tapered Circle Hanging Banner
TB-12H02



Rectangle Hanging Banner
TB-12H03



Square Hanging Banner
TB-12H04



Cube Hanging Banner
TB-12H08



Cube Hanging Banner
TB-12H09



Curved Triangle Hanging Banner
TB-12H05



Triangle Hanging Banner
TB-12H06



Pinwheel Hanging Banner
TB-12H07



Football Hanging Banner
TB-12H10



Cross Hanging Round
TB-12H11



Tapered Triangle
TB-12H12

Hanging Ceiling Signs Specification

Item	TB-12H01	TB-12H02	TB-12H03	TB-12H04	TB-12H05	TB-12H06
Name	Circle	Tapered Circle	Rectangle	Square	Curved Triangle	Triangle
Structure						
Size	D5'xH2.5' D10'xH2' D20'xH4'	10-D8'xH3.5' 14'-D12'xH4' 15'-D13'xH4'	L20'xW10'xH4'	L8'xH3.5' L16'xH4' L20'xH4'	D12'xH4'	L10'xH3.5' L14'xH3.5' D20'xH4'

Hanging Ceiling Signs Specification

Item	TB-12H07	TB-12H08	TB-12H09	TB-12H10	TB-12H11	TB-12H12
Name	Pinwheel	Cube	Cube	Football	Horizontal Round Hanging Panel	Vertical Round Hanging Panel
Structure						
Size	10'x3' 14'x5' 16'x5'	800x600x600 1000x800x800 1400x1200x1200	800x800x800 1000x1000x1000 1400x1400x1400	10'-CL2.75'xH3.5' 10'-CL2.75'xH4' 12'-D3.25'xH5'	D5'	D5'

Component Schematic



CHANGING ROOM

Tension fabric easy tube changing room is your first option for a portable changing room solution in exhibition or clothing shopping store, rooms covered by dye sublimation printed tension fabric, it can be a good sign for advertising as well.



Changing Room
TB-09V01



Changing Room Specification

Item	TB-09V01
Frame size(mm)	1200x1200x2280
Graphic Size(mm)	3200x2280
Gross Weight(Kg)	10.8
Packing Size(cm)	27x27x102

Changing Room Component schematic

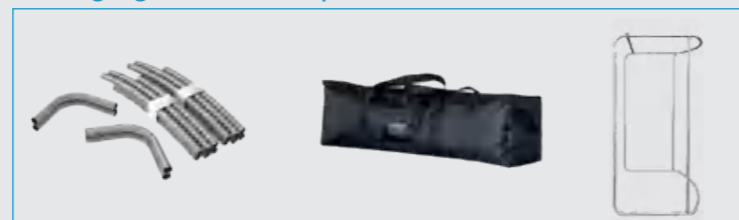

ARCH SERIES

Arch series add architecture and design to any event or interior space! Easily create and define a stunning entryway, focal point or stage set at your next trade show or event. Square arch combines pillowcase style stretch fabric graphics with 32mm curved aluminum tube ourselves and collapse to a fraction of their size. Arch packs easily into one carrying bag.



Square arch
TB-16E01



Singular Arch
TB-16E02



Round Arch
TB-16E03



Customized Design-Arch
TB-16E04

Arch Series Specification

Item	TB-16E01	TB-16E02	TB-16E03	TB-16E04
Frame size(mm)	2400x1000x2300	2700x2300x1000/600	600x1000x4000	2700x2300x1000/600
Graphic Size(mm)	7000x1000	4239x1000	9420x1000	4239x1000
Gross Weight(Kg)	15.2	10.6	22.8	16
Packing Size(cm)	37x37x75	27x27x103	36x25x123	37x37x75

Arch Component schematic



TABLE COVER

Table throws are a great addition to trade shows, conferences, exhibitions and expos with your logo and branding. Available in full graphic prints.

Table Throw

4ft-6ft / 6ft-8ft convertible table throw is available



Throw Table Cover
TB-PTC010

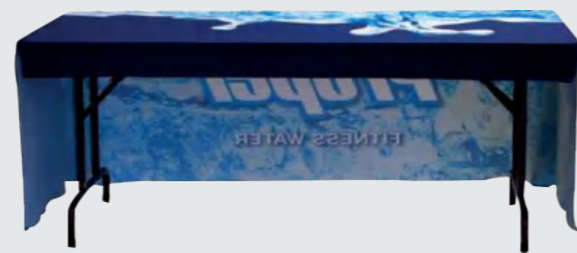

Throw Table Cover
TB-PTC011

4 Sides Table Throw

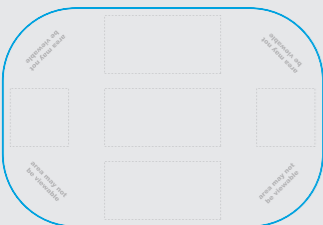

Item	TB-PTC010		
Size	4ft 262x215cm 103.1x84.6inch	6ft 323x215cm 127.1x84.6inch	8ft 383x215cm 150.8x84.6inch
Net Weight	1.4kg/3.08lbs	1.7kg/3.75lbs	2kg/4.4lbs
Packing Size	30x40x40cm/10pcs	36x40x40cm/10pcs	45x40x40cm/10pcs

3 Sides Table Throw

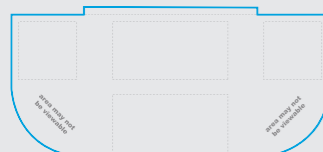

Item	TB-PTC011		
Size	4ft 262x153cm 103.1x60.2inch	6ft 323x153cm 127.1x60.2inch	8ft 383x153cm 150.8x60.2inch
Net Weight	1kg/2.2lbs	1.15kg/2.53lbs	1.4kg/3.08lbs
Packing Size	25x40x40cm/10pcs	30x40x40cm/10pcs	30x40x40cm/10pcs

Stretch Table Cover



Stretch Table Cover
TB-PTC020

Stretch Table Cover

Item	TB-PTC020		
Size	4ft 122x75x75cm 42x30x30inch	6ft 183x75x75cm 72x30x30inch	8ft 244x75x75cm 96x30x30inch
Net Weight	0.8kg/1.75lbs	1kg/2.2lbs	1.35kg/3lbs
Packing Size	25x30x40cm/10pcs	25x40x40cm/10pcs	30x40x40cm/10pcs

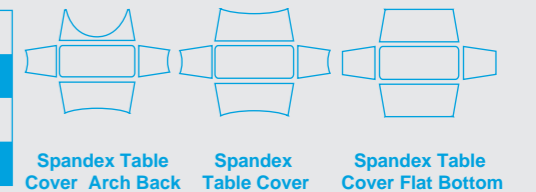

Spandex Table Cover Arch Back Spandex Table Cover Spandex Table Cover Flat Bottom



Fitted Table Cover
TB-PTC030

4 Sides Fitted Table Cover

Item	TB-PTC030		
Size	4ft 122x75x75cm 42x30x30inch	6ft 183x75x75cm 72x30x30inch	8ft 244x75x75cm 96x30x30inch
Net Weight	0.95kg/2.1lbs	1.35kg/3lbs	1.66kg/3.65lbs
Packing Size	25x40x40cm/10pcs	30x40x40cm/10pcs	30x40x40cm/10pcs

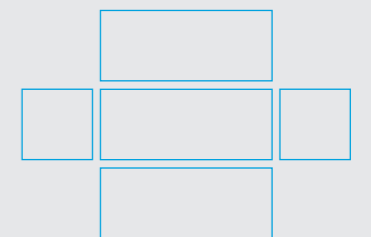

3 Sides Fitted Table Cover

Item	TB-PTC031		
Size	4ft 122x75x75cm 42x30x30inch	6ft 183x75x75cm 72x30x30inch	8ft 244x75x75cm 96x30x30inch
Net Weight	0.75kg/1.65lbs	1kg/2.2lbs	1.22kg/2.7lbs
Packing Size	25x30x40cm/10pcs	25x40x40cm/10pcs	30x40x40cm/10pcs

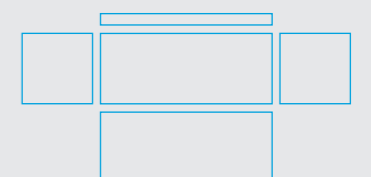

Fitted Table Cover

Custom fitted table covers come in all shapes and sizes and there is no longer what one might call a standard size table.

BOOTH SOLUTION

Our standard booths are assembled from our wide range of display stands. Custom shaped and sizes booths are available too.

Booth Assembled From

Select The Display Stands To Make Your Booth

Column Stand TB-17C01

Semi-Arch G11

Straight Wall TB-11W14

Square Counter TB-06C3

65 Booth

BOOTH SOLUTION

Booth Solution Series, including the standard combination, concave series series, multi-storey ceiling hanging banner series, arch series and customized series, we provide a range of 10ft, 20ft, 30ft booth solution, which will be a suitable for your needs.

10x10ft Standard Booth Solutions

10x10ft standard booth solution designed with more standard sized frames to combine unique designs for 10ft booth which meet more standard demand against the tradeshow needs.

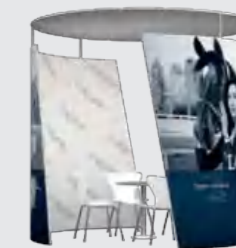

Booth 10-01



Booth 10-02



Booth 10-03



Booth 10-04



Booth 10-05



Booth 10-06



Booth 10-07



Booth 10-08



Booth 10-09



Booth 10-10



Booth 10-11



Booth 10-12



Booth 10-13



Booth 10-14



Booth 10-15



Booth 10-16



Booth 10-17

10x20ft Standard Booth Solutions

10x20ft standard booth solution designed with more standard sized frames to combine unique designs for 10ft booth which meet more standard demand against the tradeshow needs.



Booth 1020-01



Booth 1020-02



Booth 1020-03



Booth 1020-16



Booth 1020-17



Booth 1020-18



Booth 1020-04



Booth 1020-05



Booth 1020-06



Booth 1020-19



Booth 1020-20



Booth 1020-21



Booth 1020-07



Booth 1020-08



Booth 1020-09



Booth 1020-22



Booth 1020-23



Booth 1020-24



Booth 1020-10



Booth 1020-11



Booth 1020-12



Booth 1020-25



Booth 1020-26



Booth 1020-27



Booth 1020-13



Booth 1020-14



Booth 1020-15



Booth 2020-01



Booth 2020-02



Booth 2030-01



Booth 2030-02

20x20ft Standard Booth Solutions

20x30ft Standard Booth Solutions

BOOTH ACCESSORIES SERIES

The arch series is an ideal dimensional accessory to connect to a tension fabric display 20ft or 30ft straight backwall that is being used in a Island exhibit space. It features a simply tube frame, pillowcase fabric graphic canopy, table top and connects easily to create the appearance of one seamless display.

Arch Accessories

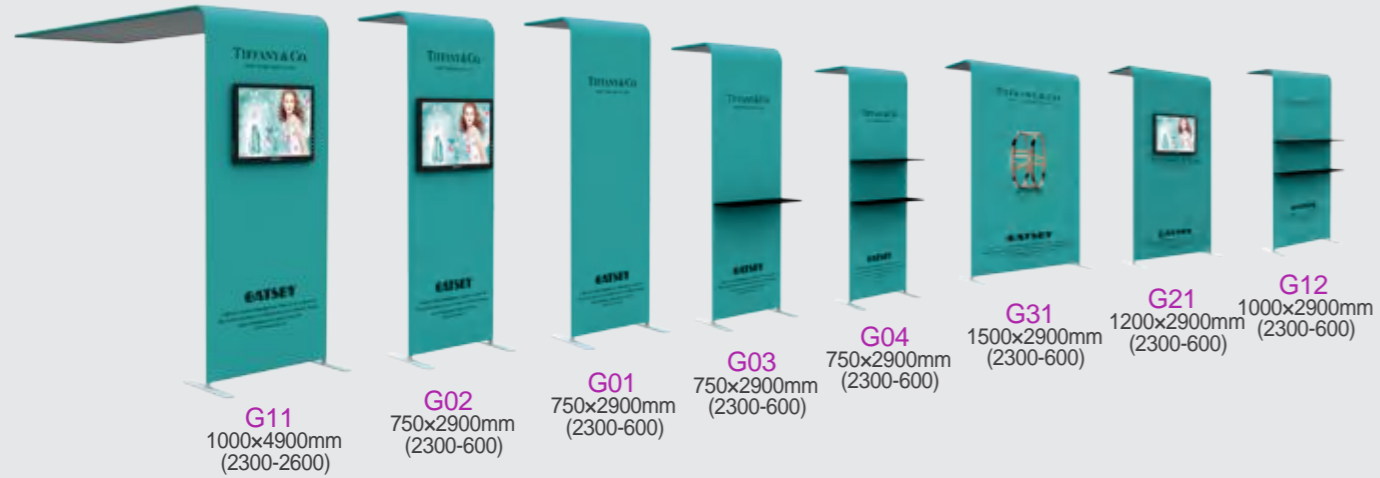

Foot Accessories

Aluminum Foot

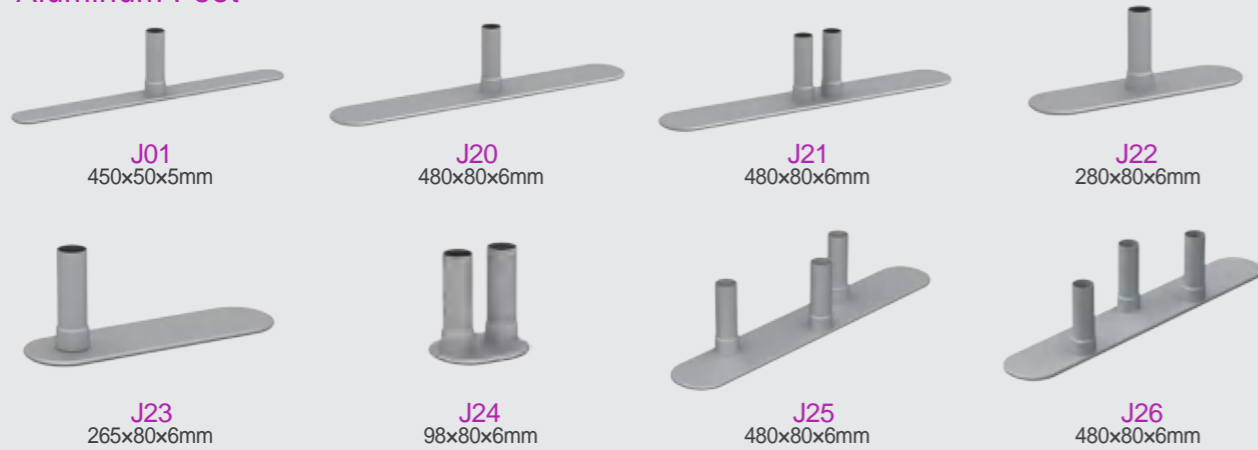

Steel Foot

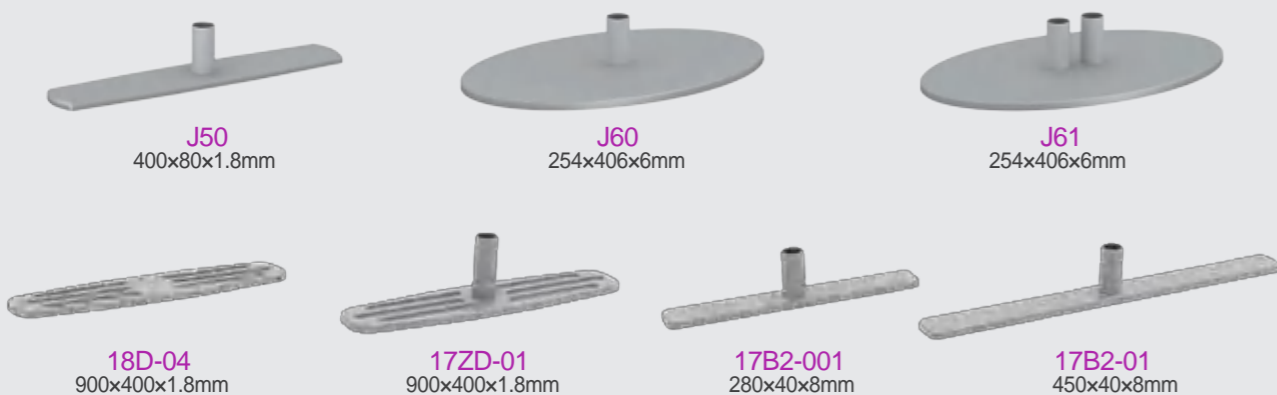

Standard sized A series

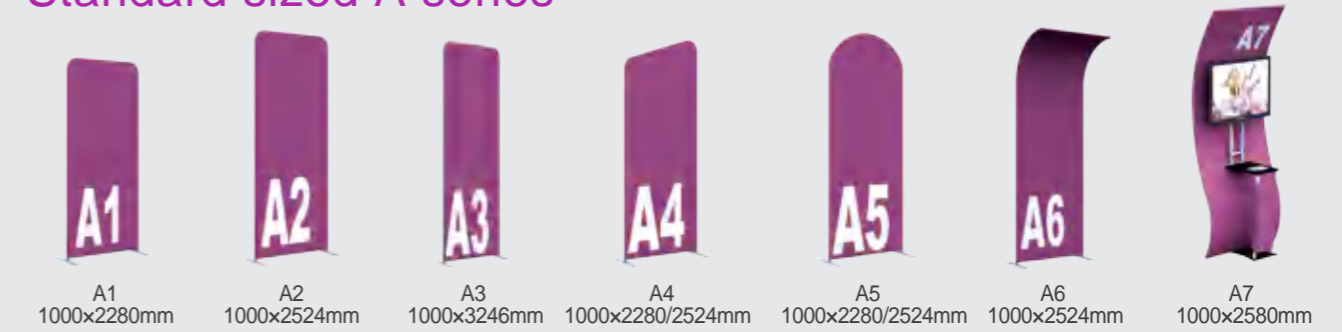

Standard sized B series



Standard sized C series



Standard sized D series

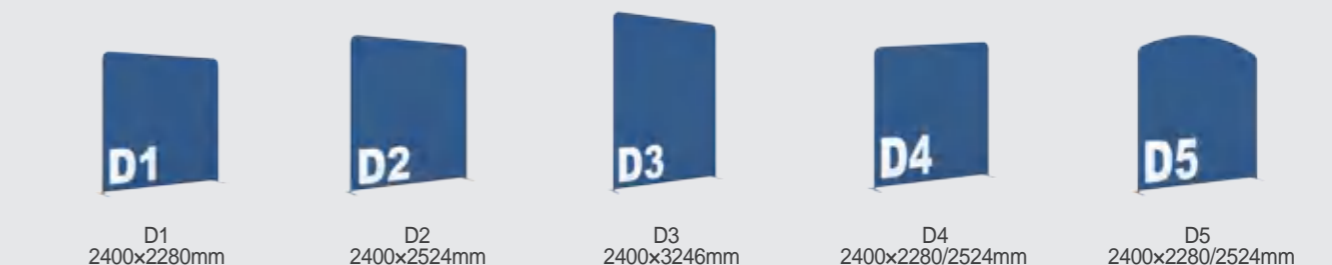

APPLICATION ACCESSORIES

Application accessories series including the straight, u-shaped application shelves which will be more optional design for you to combine.



Z01 Z02 Z03 Z04

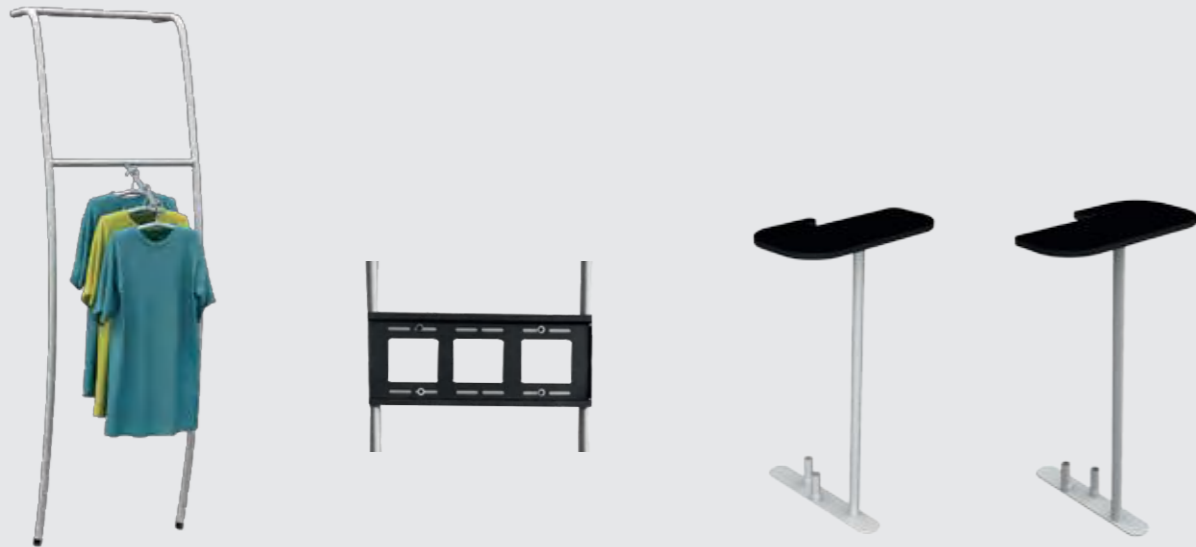

Z13 LBF50 Z05 Z06

Application Accessories Series Specification

Item	Z01	Z02/Z13	Z03	Z04	Z05/Z06	LBF50
Size(mm)	710x2283	710x2283	710x2316	710x2316	710x2316	450x200
Weight(Kg)	13	9	11.5	11	4	3.2
Packing Size(cm)	35x24x83	35x18x83	35x18x83	35x24x83	33x16x59	49x23x7

LIGHTING SERIES

LED lamps with various electricity standard all over the world.
Plug Standard:WORLD WIDE



M09H17 M09H20



ABS lights Clip

Package Cases



Size:70x44x103cm Size: 42x38x100cm Size: 90x26x13cm
P07E07 P08E08 P06E06



As counter / As case

Size: 95.8x47x32.1cm
P06E13

FABRICS

There is several fabric options for each product, you can select the fabric in our printed fabric sample book.

01. 600D Oxford Cloth



01 T-shirt Top and 100% Cotton Short Sleeve T-shirt Cover etc. TUFADVERTISING

Gram Weight	Max Width
250g/88oz	150cm/59in

02. 110g polyester



02 Flying Paper/Rectangle/Custom Paper etc. TUFADVERTISING

Gram Weight	Max Width
110g/3.9oz	160cm/63in

03. 80D polyester pongee



03 Double Sided Flying Paper etc. TUFADVERTISING

Gram Weight	Max Width
85g/3oz	160cm/63in

04. 270g polyester



04 Pop Up Displays/2D Table Fabric/Display Table Cover etc. TUFADVERTISING

Gram Weight	Max Width
250g/8.8oz	320cm/126in

05. 300g opaque polyester



05 Photo Displays/2D Table Fabric/Display Table Cover etc. TUFADVERTISING

Gram Weight	Max Width
300g/10.6oz	320cm/126in

06. 210g polyester



06 2D Table Fabric/Display Table Cover etc. TUFADVERTISING

Gram Weight	Max Width
210g/7.4oz	320cm/126in

07. 200g stretch polyester



07 Double Table Cover etc. TUFADVERTISING

Gram Weight	Max Width
200g/7.05oz	160cm/63in

08. 200g satin



08 Roll Up Garments Hanging Garment etc. TUFADVERTISING

Gram Weight	Max Width
200g/7.05oz	220cm/86.5in

09. light box fabric



09 Light Box Fabric etc. TUFADVERTISING

Gram Weight	Max Width
180g/6.35oz	320cm/126in

10. 230g polyester



10 Pop Up Displays/Rectangle/Rectangle Table Cover etc. TUFADVERTISING

Gram Weight	Max Width
230g/8.1oz	320cm/126in

11. 130g satin



11 Rectangle Paper and Banner Hanging Banner etc. TUFADVERTISING

Gram Weight	Max Width
130g/4.55oz	145cm/57in

12. mesh polyester



12 Flying Banner/Frame Banner etc. TUFADVERTISING

Gram Weight	Max Width
115g/4.05oz	160cm/63in

13. mesh polyester

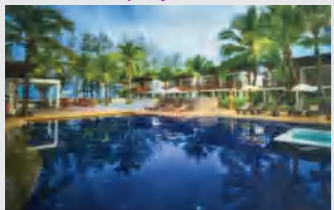

13 Flying Banner/Frame Banner etc. TUFADVERTISING

Gram Weight	Max Width
115g/4.05oz	160cm/63in

14. 130g polyester

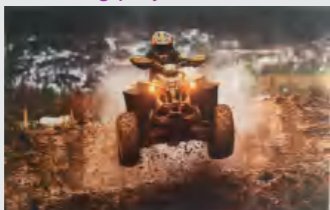

14 Flying Banner/Frame Banner etc. TUFADVERTISING

Gram Weight	Max Width
130g/4.55oz	160cm/63in

15. 280g stretch fabric



15 Counter Flying Table Cover Inflatable Sails etc. TUFADVERTISING

Gram Weight	Max Width
280g/9.88oz	200cm/78.7in

16. silver coated fabric



16 H&G Polyester With Silver Coated etc. TUFADVERTISING

Gram Weight	Max Width
145g/5.1oz	160cm/63in

HOW TO ORDER

Process >>>



Artwork >>>

- * Resolution - 150-300 DPI at Full Size or Vector File
- * Color Model - CMYK
- * Size - Full Size or Scale Set Vector File
- * Fonts - Outlined, Images - Embedded
- * Preferred File Type - PDF | Acceptable Files - TIFF, JPG, PSD, AI, EPS

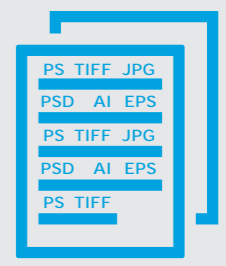

Files transfer link — [wetransfer](#) | [HIGHTAIL](#) | [Dropbox](#) | [mailbigfile](#)

Business Support >>>

3D Pictures
 Templates
 Instructions
 Blind Drop Shipping

FAQ >>>

1. Blind drop shipping?
If you are a reseller, would like to ship your order to your customer from us, we can note your information as shipper, your customer will not find us.

2. Good Artwork?
In Photoshop, view your graphic at 100% scale. This is how your artwork will look when printed. Graphic dimensions must match the current template.

3. Cmyk Mode is a must?
Your graphic must be in CMYK mode. Colors may differ in RGB mode. If your graphic contains critical spot colors, ask us about our PMS Color Matching Service.

4. Proof Reading?
It is your responsibility to proof-read all your text. proofs can provide by you, we will check artwork and proofs, will process if match